

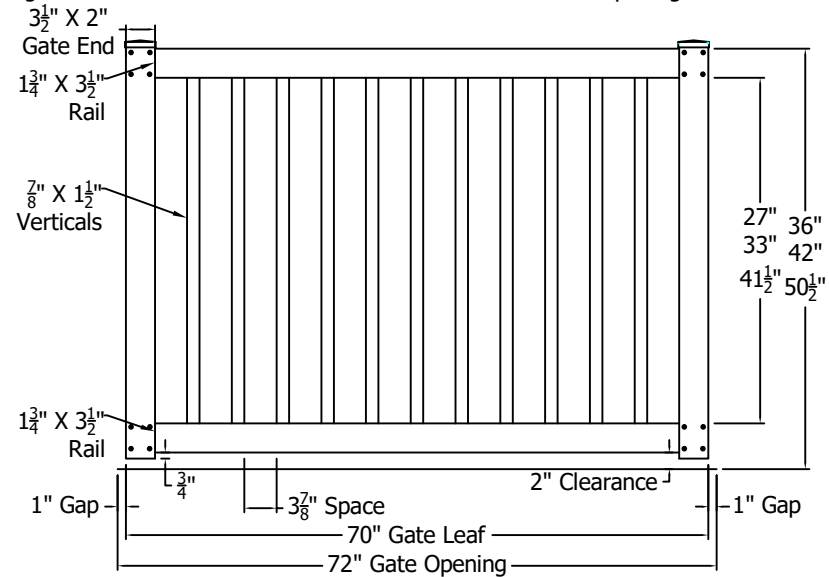

Rails And Gate Ends Reinforced With Aluminum

REV.	LOC.	REVISION	DATE
B		Updated Logos	12/22/20

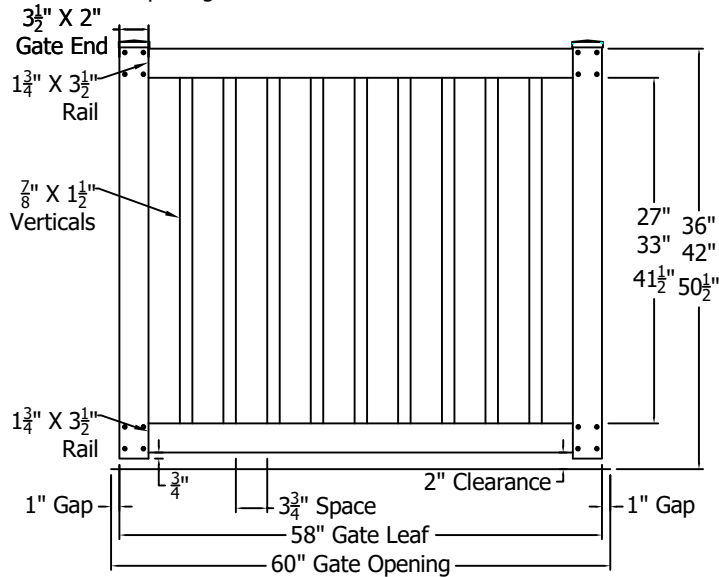
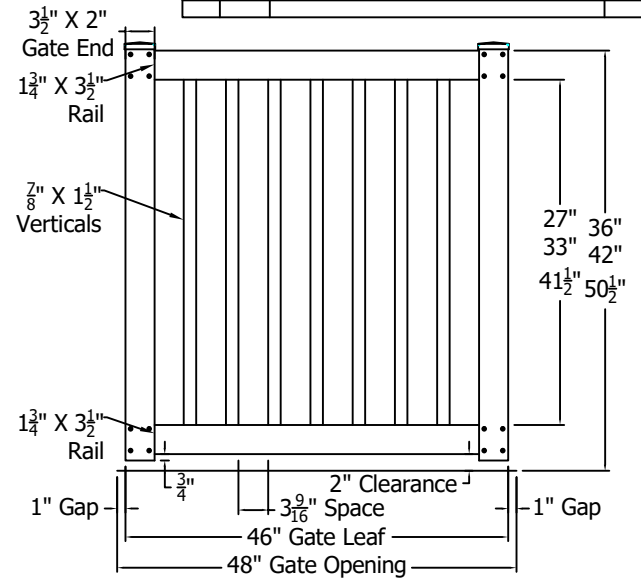
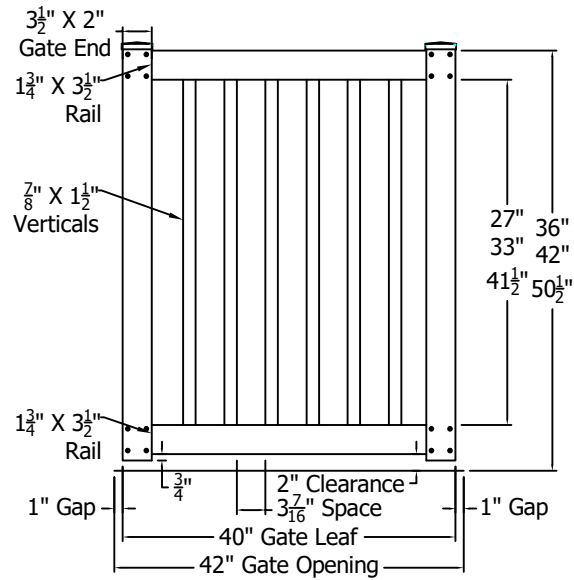
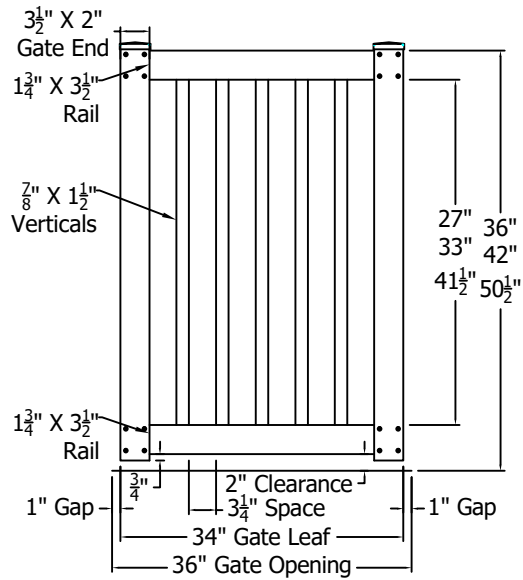

 <p><b>Polyvinyl</b> VINYL FENCING</p>	 <p><b>DSI</b> Digger Specialties Inc. <i>Transforming the Outdoor Living Experience™</i></p> <p>3446 US 6 EAST Bremen, IN 46506 diggerspecialties.com</p>	DRAWN BY: EH DATE DRAWN: 03-20-2020	STYLE: <b>GN Yard Standard Gates</b>
		SCALE = 1":1"	AS SHOWN: 48" T
		DRAFT NO.: 20200320-1E	LOC: Z:\Vinyl\Polyvinyl Fence\Good Neighbor\Updated Standard Drawings
		REV. B	

4

3

2

1

D

C

B

A