

# Bella Cavo (IRC Post Mount)

(Style C90 & C91)

## Installation Instructions



- It is the responsibility of the installer to meet all code and safety requirements, and to obtain all required building permits. The installer should determine and implement the installation techniques appropriate for each unique installation situation. Digger Specialties, Inc. and its distributors shall not be held liable for improper or unsafe installations.
- These instructions must be followed exactly as written and the materials used must be exactly as shown in the instructions. Any deviation from the instructions or variation in the materials used/installed may result in an unsuccessful installation and will void the warranty.

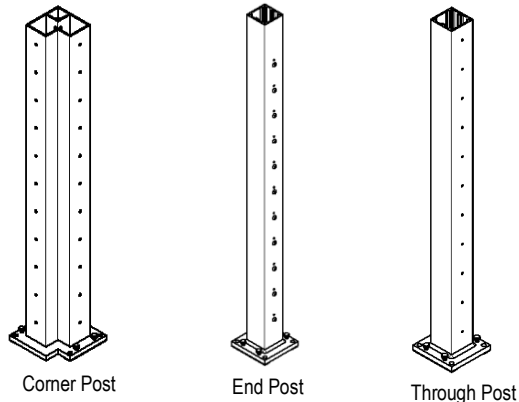

**Note:** If you are not using a corner post at the top of your stairs. Go to Double Post Mounts.

### Stair & Level Post Mount (Corner Post)

- Begin 1st by placing your Stair post. This step is important when using a corner post at the top of your stairs. This is required so the corner post and through post will line up with corner post at top of stairs.
- Determine location of corner post at top of stairs. See (Example 1) below.
- Add backer blocking where required to support post.
- To center a fastener on the outer rim board of a 2x8 or 2x10 deck frame, place it  $\frac{3}{8}$ " from the outer edge. For the corner post and through post to align with the top stair's corner post, measure  $1-\frac{7}{8}$ " from the deck framing's edge.

**Note:** Max straight run between end post is 100 feet. For each corner through posts reduced this by 10%. **Example:** Two tensioning posts plus one corner through post will be 90 feet. Max number of corners allowed with 90° angle is two. Max number with 45° angle is four.

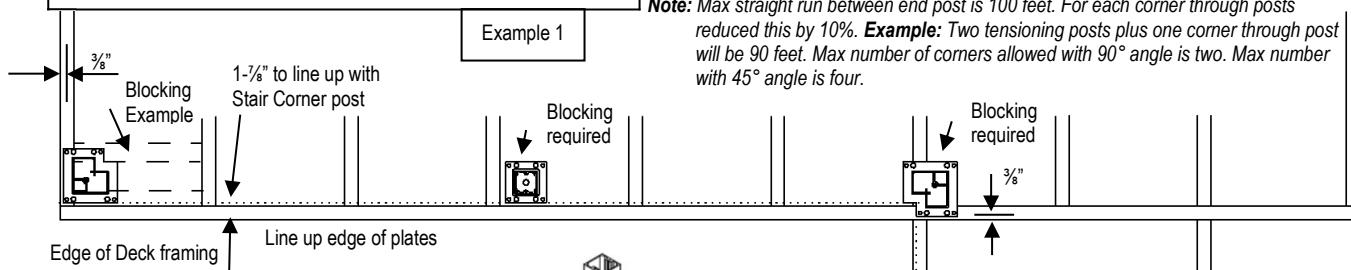

If doing a bolt through method for post install, placement will be different.  
When using lag screw method use  $\frac{3}{8}$ " x 5" minimum length with at least 4" of blocking.

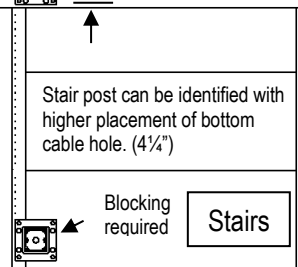
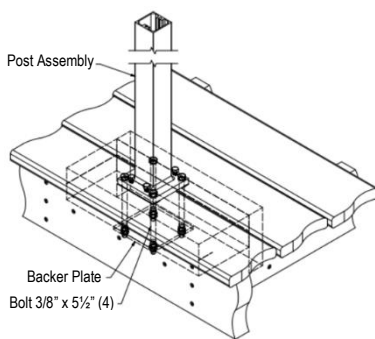

- Position post on the steps with a string approximately 1" from nose of steps. String needs to line up with cable hole on each post. (Example 2)
- Measure from nose of tread board to post plate. Use this measurement to set all stair posts.
- All other post on deck will be placed  $\frac{3}{8}$ " from plate to edge of deck framing.
- Attach 2-piece flairs to all posts.

- Separate two-piece flair.
- Slide u-shaped flair around bottom of post.
- Use rubber mallet to tap snap piece to flair.

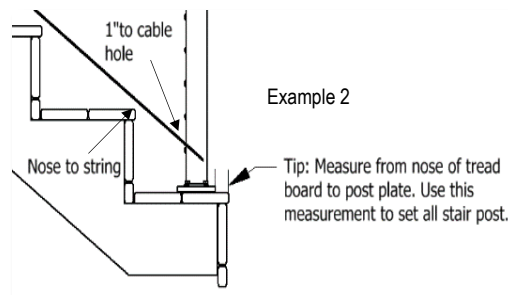

# Bella Cavo (IRC Post Mount)

(Style C90 & C91)

## Installation Instructions



- It is the responsibility of the installer to meet all code and safety requirements, and to obtain all required building permits. The installer should determine and implement the installation techniques appropriate for each unique installation situation. Digger Specialties, Inc. and its distributors shall not be held liable for improper or unsafe installations.
- These instructions must be followed exactly as written and the materials used must be exactly as shown in the instructions. Any deviation from the instructions or variation in the materials used/installed may result in an unsuccessful installation and will void the warranty.

### Stair & Level Post Mount (Double Post)

Post placement will be the same if using 45° angle post on deck .

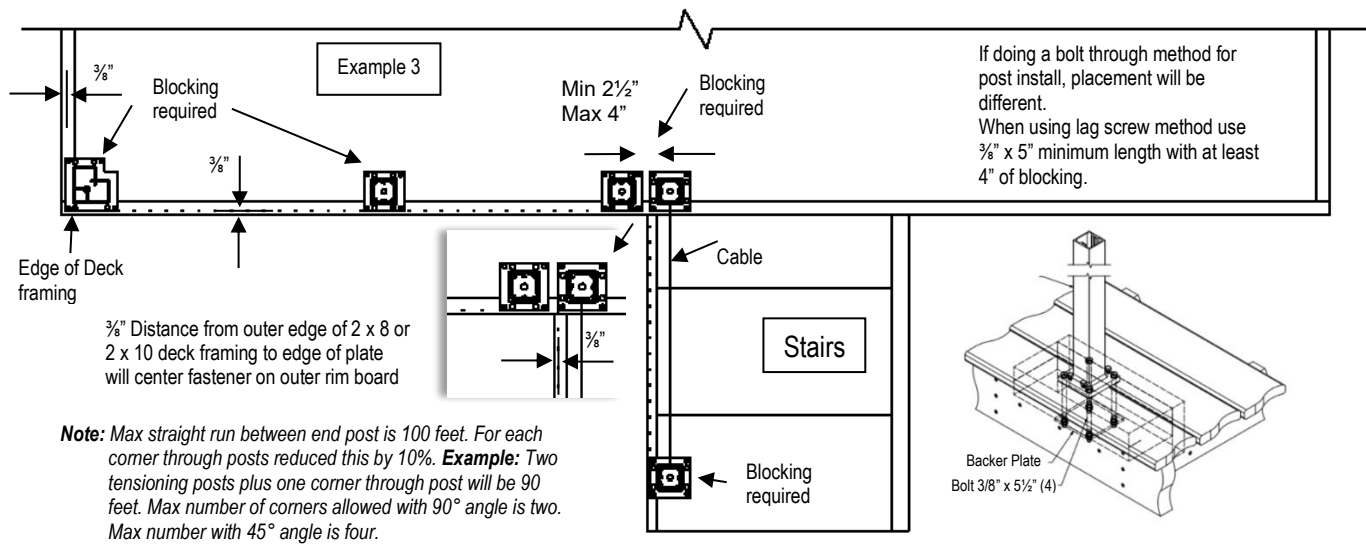

- Begin 1st by placing your Stair post. When using a double end post at the top of the stairs, post placement minimum apart is 2½". Maximum between post is 4".
- Determine location of End post at top of stairs. See (Example 3).
- Add backer blocking where required to support post.
- Position post on the steps with a string approximately 1" from nose of steps. String needs to line up with cable hole on each post. (Example 4)
- Measure from nose of tread board to post plate. Use this measurement to set all stair posts.
- All post on deck will be placed ¾" from plate to edge of deck framing.
- Attach 2-piece flairs to all posts.
  - Separate two-piece flair.
  - Slide u-shaped flair around bottom of post.
  - Use rubber mallet to tap snap piece to flair.

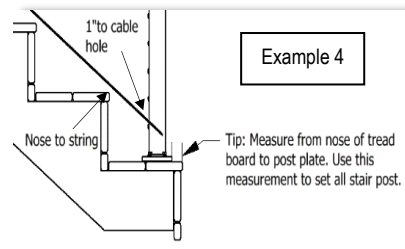

### Care and Cleaning      Warranty

Remove all particles and residue from Westbury aluminum components by referring to the Care and Cleaning requirements on the DSI website. Scan Below:

For product Warranty and Registration please scan below:

