

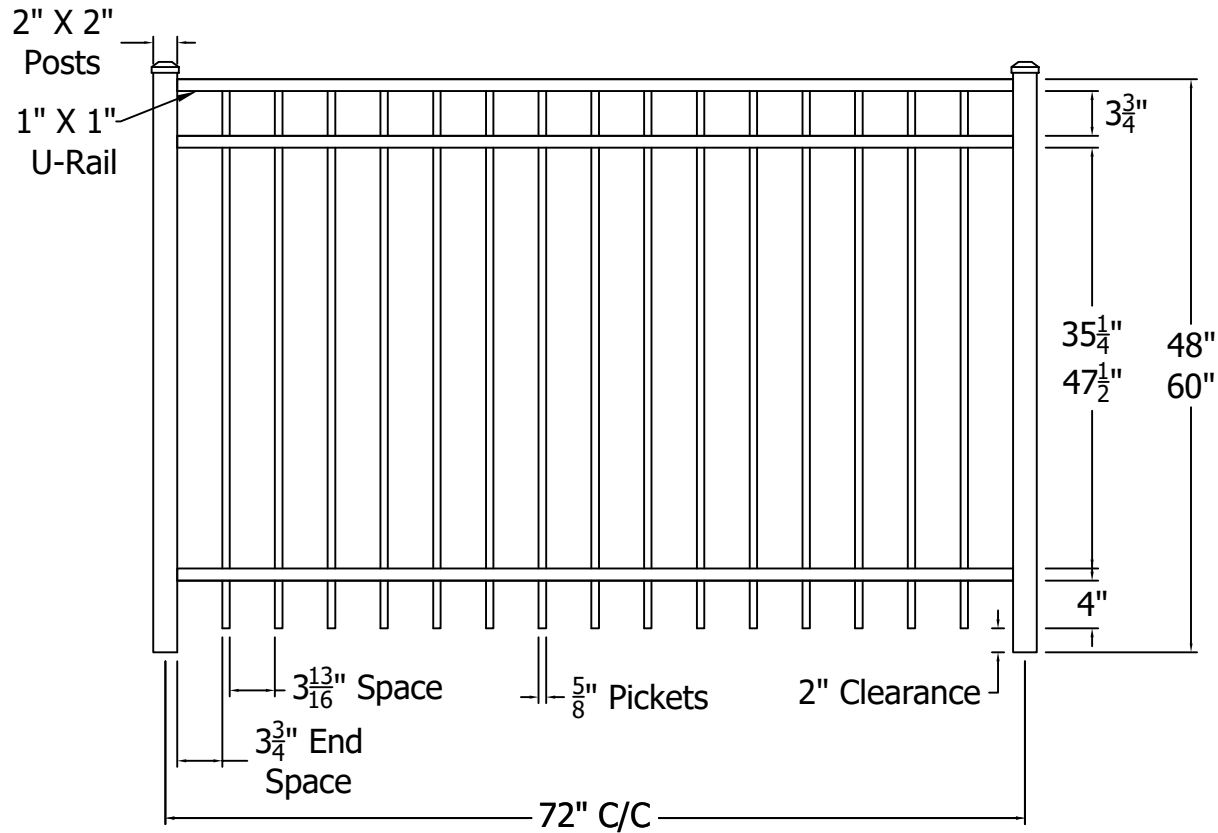

REV.	LOC.	REVISION	DATE



	 <i>Transforming the Outdoor Living Experience™</i> 3446 US 6 EAST Bremen, IN 46506 diggerspecialties.com	DRAWN BY: EH	STYLE:
		DATE DRAWN: 03-04-2021	6230
		SCALE = 1":1"	AS SHOWN: 48" T
DRAFT NO.: 20210304-1E	LOC: Z:\Aluminum\Regis\6000 Series\6000 Series Sections\Updated Standard Drawings	REV. A	

4

3

2

1

D



C

B

A

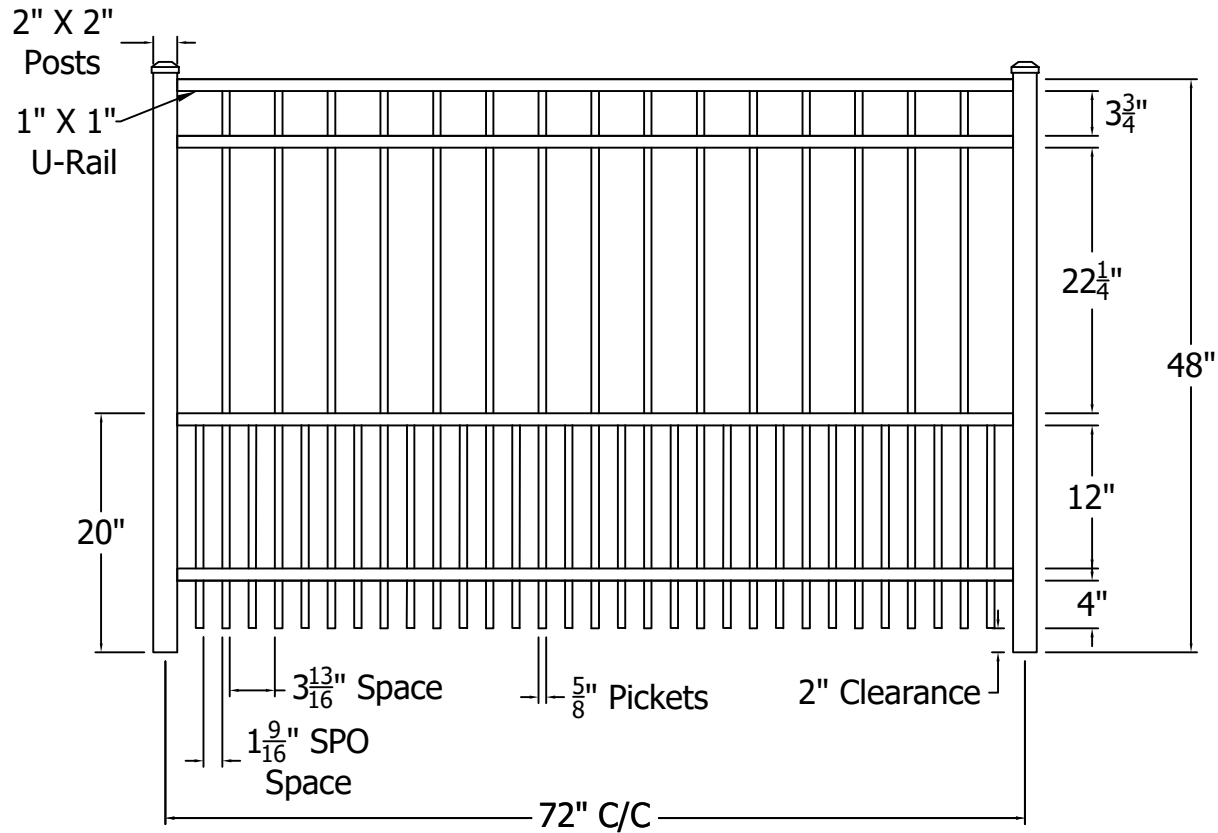

REV.	LOC.	REVISION	DATE



	 <p>3446 US 6 EAST Bremen, IN 46506 diggerspecialties.com</p>	DRAWN BY: EH	STYLE:	A
		DATE DRAWN: 03-04-2021	6230 SPO	
		SCALE = 1":1"	AS SHOWN: 48" T	
		DRAFT NO.: 20210304-1E	LOC: Z:\Aluminum\Regis\6000 Series\6000 Series Sections\Updated Standard Drawings	REV. A
4	3	2	1	

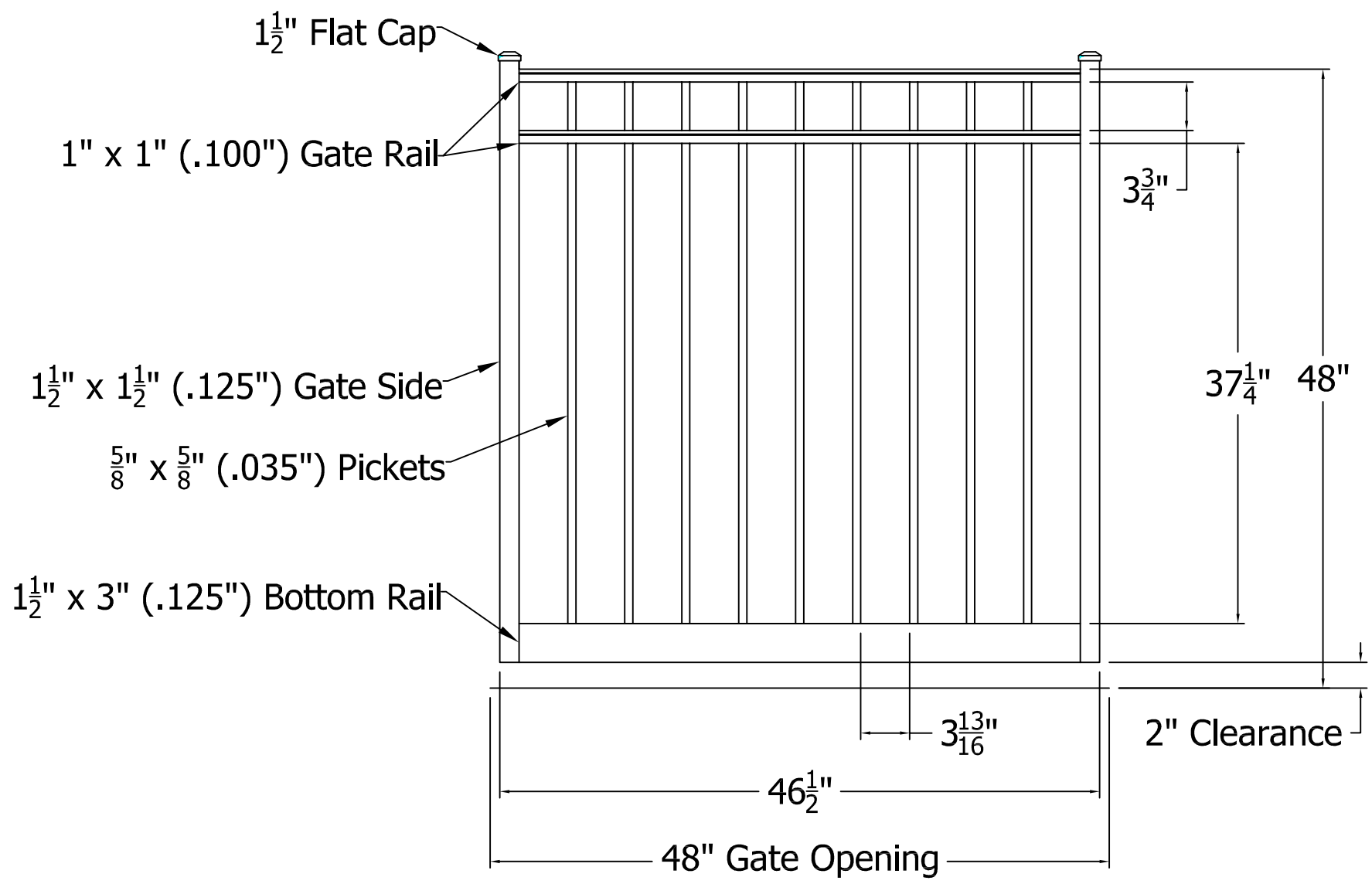

REV.	LOC.	REVISION	DATE
A		RELEASE PENDING APPROVAL	



	 <p>3446 US 6 EAST Bremen, IN 46506 diggerspecialties.com</p>	SHEET SIZE= C	DRAWN BY: CM	PART NUMBER or STYLE: 6230 48W
		SCALE = 1":1"	DATE DRAWN: 02-24-2017	
STANDARD TOLERANCE: .00 ±.01 FRACTIONS: .000 ±.005 ±1/16" ANG. ±.5°	FIRST USED ON:	LOC: Z:\Aluminum\Regs\6000 Series\6000 Series Gates	Quote Requested by:	
		DRAFT: 20170224-2C	PART NAME: U-Frame Gate	SHEET of

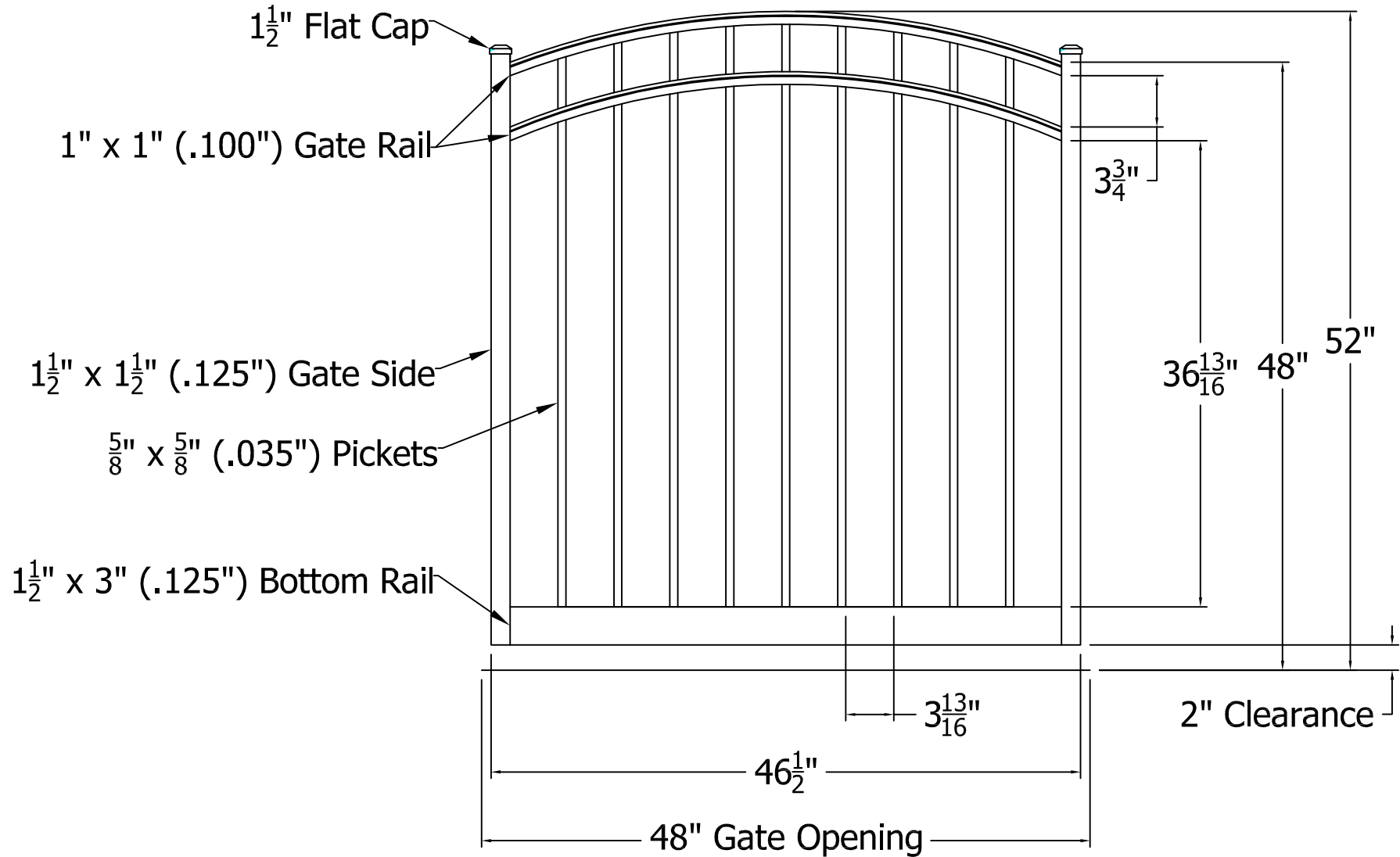

REV.	LOC.	REVISION	DATE
A		RELEASE PENDING APPROVAL	



	 <p>3446 US 6 EAST Bremen, IN 46506 diggerspecialties.com</p>	SHEET SIZE= C	DRAWN BY: CM	PART NUMBER or STYLE: 6230 48W Arch
		SCALE = 1":1"	DATE DRAWN: 03-15-2017	
STANDARD TOLERANCE: .00 ±.01 FRACTIONS: .000 ±.005 ANG. ±.5° ±1/16"		LOC: Z:\Aluminum\Regs\6000 Series\6000 Series Gates\Arch	Quote Requested by:	
FIRST USED ON:	DRAFT: 20170315-7C	PART NAME: U-Frame Gate	SHEET OF	REV. A

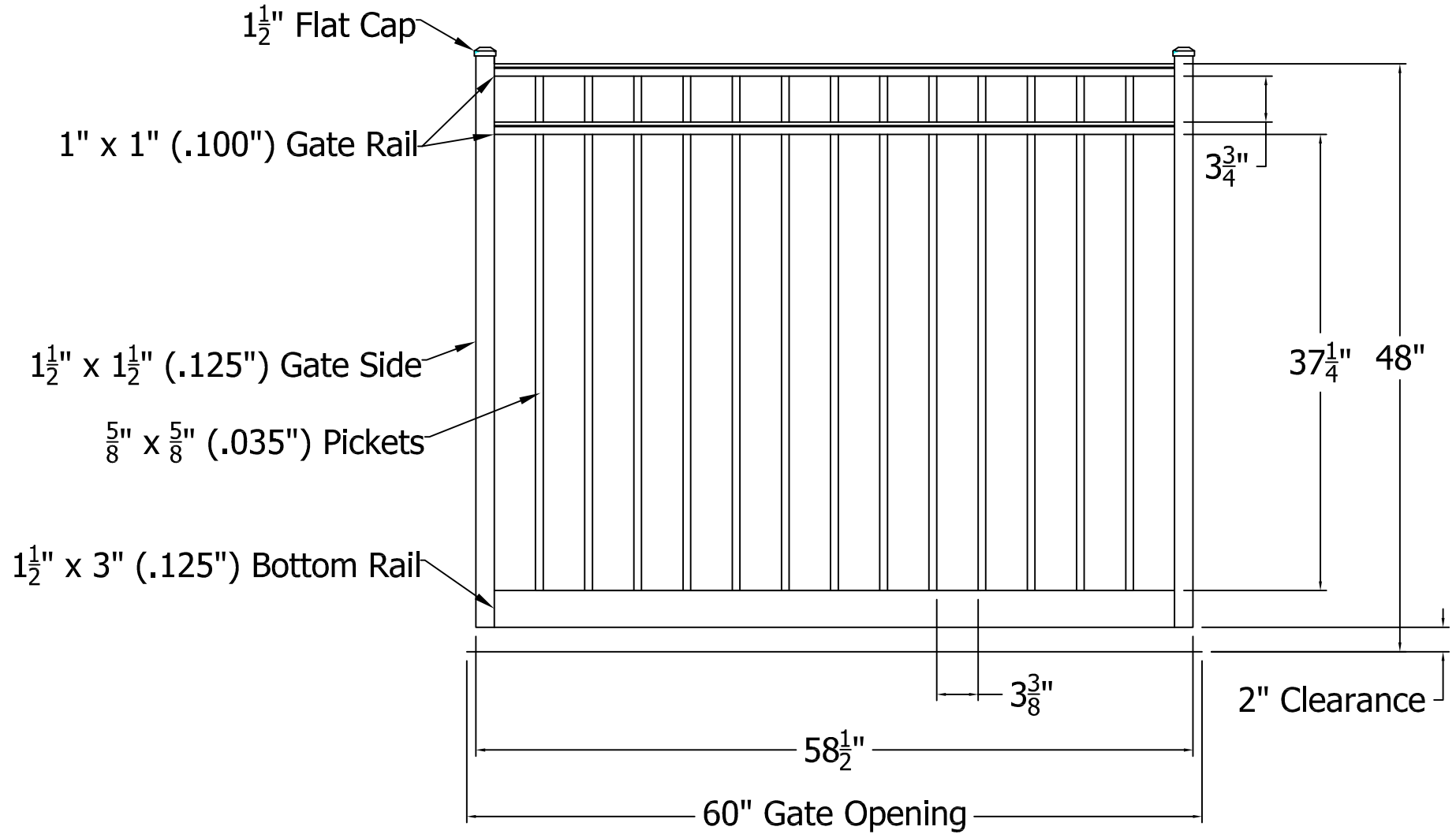

REV.	LOC.	REVISION	DATE
A		RELEASE PENDING APPROVAL	

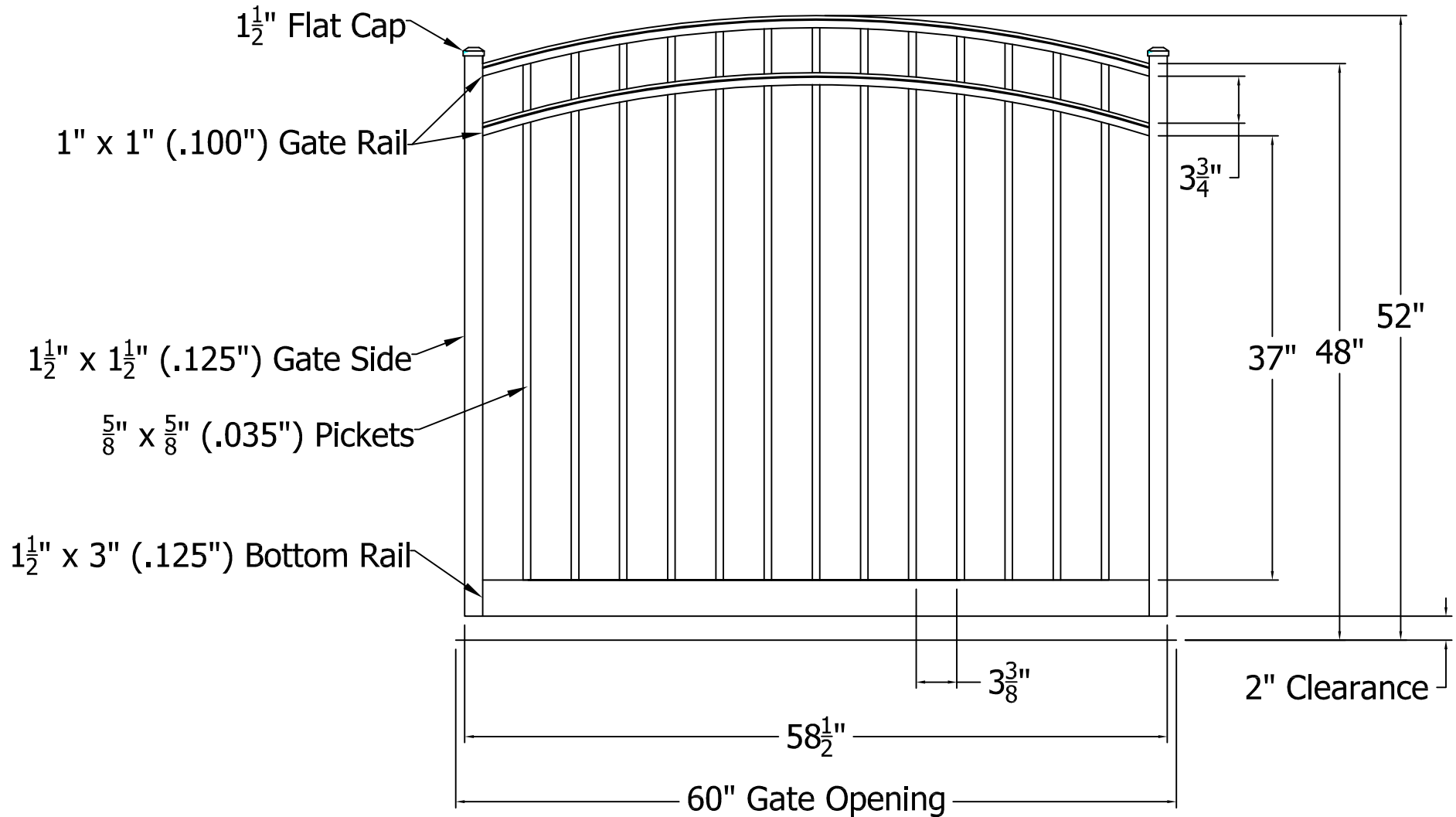

	 DSI Digger Specialties Inc. <i>Transforming the Outdoor Living Experience!</i> 3446 US 6 EAST Bremen, IN 46506 diggerspecialties.com	SHEET SIZE= C	DRAWN BY: CM	PART NUMBER or STYLE: 6230 60W	
		SCALE = 1":1"	DATE DRAWN: 02-24-2017	Quote Requested by:	
STANDARD TOLERANCE: .00 ±.01 FRACTIONS: .000 ±.005 ±1/16" ANG. ±.5°		LOC: Z:\Aluminum\Regls\6000 Series\6000 Series Gates	FIRST USED ON:	DRAFT: 20170224-3C	PART NAME: U-Frame Gate
			SHEET OF	REV. A	

REV.	LOC.	REVISION	DATE
A		RELEASE PENDING APPROVAL	



 Regis® ALUMINUM FENCING	 Digger Specialties Inc. <i>Transforming the Outdoor Living Experience!</i> 3446 US 6 EAST Bremen, IN 46506 diggerspecialties.com	SHEET SIZE= C SCALE = 1":1" STANDARD TOLERANCE: .00 ±.01 FRACTIONS: .000 ±.005 ±1/16" ANG. ±.5°	DRAWN BY: CM DATE DRAWN: 03-15-2017	PART NUMBER or STYLE: 6230 60W Arch
		FIRST USED ON: DRAFT: 20170315-8C	LOC: Z:\Aluminum\Regs\6000 Series\6000 Series Gates\Arch	Quote Requested by: