

Riviera Series

(Style C30, C301, C30R, C301R, C31, C311, C32, C321, C33, C331, C34, C341)
Installation Instructions



- It is the responsibility of the installer to meet all code and safety requirements, and to obtain all required building permits. The installer should determine and implement the installation techniques appropriate for each unique installation situation. Digger Specialties, Inc. and its distributors shall not be held liable for improper or unsafe installations.
- These instructions must be followed exactly as written and the materials used must be exactly as shown in the instructions. Any deviation from the instructions or variation in the materials used/installed may result in an unsuccessful installation and will void the warranty.

Standard (Level) Railing

Note: Top rail is 1" longer on each end to accommodate Crossover Railing.

- Cut the rails to length by holding rails against posts. Position so there will be the same baluster spacing on each end of the rails if possible. Mark rails where they are to be cut. **Make sure rail is cut 1/4" shorter on each end to allow for mounts.** Cut rails and vinyl insert. A minimum of 1 1/4" spacing is required between first baluster and post (Example 1).

Crossover railing: Cut bottom and mid rail as shown (Example 1). For top rail, make end spacing exactly 1" longer on all ends connecting to a line crossover post (Example 2). Cut vinyl insert 1/4" shorter than rail on end with crossover post.

If connecting to a corner crossover cut the top rail the same as the bottom rail.

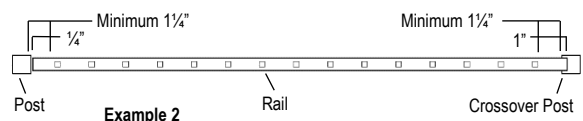
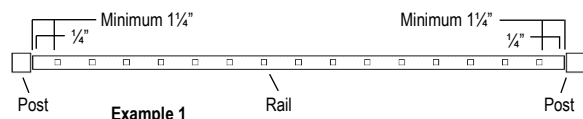

- Attach bottom wall mount to post by positioning the bottom rail so there is no more than a 2" clearance. Keeping mount centered on post, fasten mount to post with pan head self-tapping screws (provided). A 1-3/8" spacer may be placed on the welded 3/8" plate of the post to reach the 2" clearance. Use a 1-1/4" spacer for posts with 1/2" plate.
- Attach mid rail wall mount to post by measuring up 27-1/2" (for 36" Tall railing) or 33-1/2" (for 42" Tall railing) from top of bottom mount to top of mid rail mount. Keeping mount centered on post, fasten mount to post with self-tapping pan head screws (provided).
- Attach top wall mount to post by measuring up 5-1/8" from top of the mid rail mount to top of the top mount. Keeping mount centered on post, fasten mount to post with self-tapping pan head screws (provided).

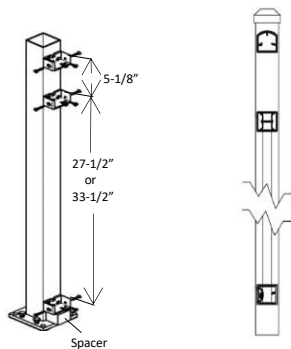

- Place bottom rail on clean flat surface. Using a rubber mallet, tap balusters into routed holes making sure balusters are seated all the way into the rail.
- Hold mid rail at an angle above balusters. Starting at one end feed first baluster into mid rail and tap lightly. Feed remaining balusters into mid rail, tapping lightly as you move to the other end of making sure all balusters are against the vinyl insert.
- (Not applicable on C30 and C301 for 4' & 5' lengths). Place small balusters into routed holes on top side of mid rail and tap lightly to making sure they seat completely against the vinyl insert in the mid rail. Note: When installing rings make sure the longer tab on the ring is facing up. Rings may need to be altered in the field to fit in ring slot in rail.
- Hold top rail at an angle above balusters. Starting at one end feed first baluster into top rail and tap lightly. Feed remaining balusters into top rail, tapping lightly as you move to the other end. Once all balusters are partially seated in top rail, go back, and tap along full length of the top rail making sure all balusters are seated against top rib.

Standard (Level) Railing cont'd

- Fasten rail support to bottom side of bottom rail by inserting pan head self-tapping screw (provided) through center of threaded portion of support. This applies to all sections over 4ft long.
- Place section in mounts. Attach top, mid, and bottom rails through side of mount with flat head self-tapping screws (provided). **Crossover railing:** Fasten top rail to crossover adaptor with pan head screws (provided).
- Carefully align mount cover on mount base before applying even, downward pressure to snap cover into place. (Mount Covers can be damaged if the above process is not followed).
- Attach 2-piece flairs to all posts.
 - Separate two-piece flair.
 - Slide u-shaped flair around bottom of post.
 - Use rubber mallet to tap flair together.

Angle (Swivel) and 45° (Fixed) Mounts

- Position bottom swivel mount base so the bottom of the rail has no more than a 2" clearance. (NOTE: A 1 3/8" spacer may be placed on the welded 3/8" plate of the post to reach the 2" clearance. Use 1 1/4" spacer for post with 1/2" plate.)
 - Measure up 27-1/2" (for 36" tall railing) or 33-1/2" (for 42" tall railing) from top of bottom mount to top of mid rail mount. Measure up 5-1/8" from top of mid rail mount to top of top rail mount.
- Keep base of mount centered and pin hole turned down, fasten bases to post with pan head self-tapping screws (provided).
- Angle the swivel mount after it is installed on post. Make sure set screw at back of cup is snug. Use a 3/32 Allen wrench to tighten if needed. Do not over tighten. Measure from back of cup at one end to back of cup at other end to determine rail length. Cut rails.
- Assemble sections as specified in Standard (Level) Railing steps 5-12.

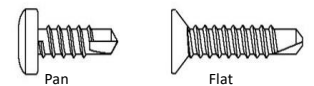

Note: If using 45° (Fixed) Mount on posts larger than 3" you will need to offset mount from center to install both side entry screws.

Stair Railing

Important: Rails must be positioned in the correct direction prior to cutting. If rails are not in the correct position, they may be cut incorrectly, and balusters will not line up. Rails will have a PINK STICKER over the small hole at one end that indicates the lower end of the stairs. For the mid rail, this hole also represents the bottom side of the rail.

- Identify top, mid, and bottom stair rails (Example 3).
- Lay bottom rail beside posts with approximately 1" clearance (use 1" spacer) between the rail and nose of step. Insert a baluster into the last hole on each end. Place mid rail on these balusters. Insert a baluster into (top side of mid rail) the last holes on each end of the mid rail. Place top rail on these balusters.
- Position rails against posts and even the end spacing on each end, **if possible**, with balusters parallel to the post. Clamp rails to post (Example 4). Mark rails for cutting (Example 5). Mark posts for each mount position (Example 6). Cut rails and vinyl inserts 3/16" shorter than mark on each end. Rails should be cut using a straight cut.

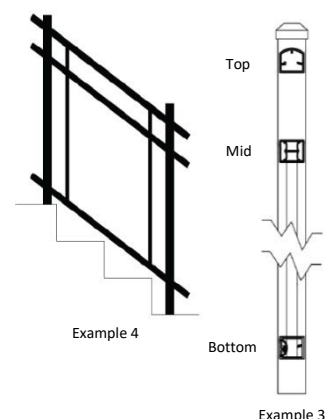

Riviera Series

(Style C30, C301, C30R, C301R, C31, C311, C32, C321, C33, C331, C34, C341)
Installation Instructions



- It is the responsibility of the installer to meet all code and safety requirements, and to obtain all required building permits. The installer should determine and implement the installation techniques appropriate for each unique installation situation. Digger Specialties, Inc. and its distributors shall not be held liable for improper or unsafe installations.
- These instructions must be followed exactly as written and the materials used must be exactly as shown in the instructions. Any deviation from the instructions or variation in the materials used/installed may result in an unsuccessful installation and will void the warranty.

Stair Railing cont'd

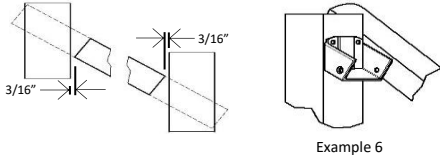

4. **Crossover Railing:** For crossover stairs, set stair crossover kit next to rails that are fastened to post to determine what height to cut post. Mark post and cut. Set crossover connector in post and fasten at proper height with self-tapping pan head screws (provided). Set correct angle for crossover connector to match railing and tighten nut. Cut bottom and mid rails same as above in step 3 (Example 5). Mark top rail to cut making sure it fits snug into the crossover connector (Example 7). Cut vinyl insert $\frac{1}{4}$ " shorter than rail on end with crossover post.



5. Attach mounts to post with pan head self-tapping screws (provided). (Example 8)

6. Place bottom rail on clean flat surface. Using a rubber mallet, tap balusters into routed holes making sure balusters are seated all the way into the rail.

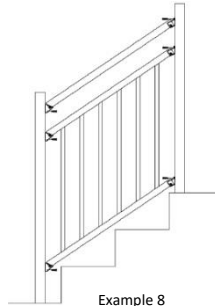
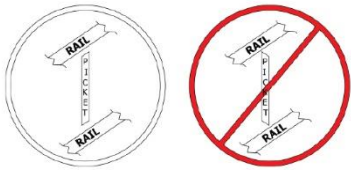

7. Hold mid rail at an angle above balusters. Starting at one end feed first baluster into mid rail and tap lightly. Feed remaining balusters into mid rail, tapping lightly as you move to the other end of the rail making sure all balusters are against the vinyl insert.
8. (Not applicable on C30 and C301 for 4' & 5' lengths). Place small balusters into routed holes on top side of mid rail, tap lightly to make sure they are seat completely against the vinyl insert in the mid rail. Note: When installing rings, the longer tab on the ring should face up. Rings may need to be altered in the field to fit in ring slot in rail.
9. Hold top rail at an angle above balusters. Starting at one end feed first baluster into rail and tap lightly. Feed remaining balusters into top rail, tapping lightly as you move to the other end. Once all balusters are partially seated in top rail, go back, and tap along full length of the top rail making sure all balusters are seated against top rib.
10. Place section in mounts. Attach top, mid, and bottom rails to mounts by inserting flat head self-tapping screws (provided) through side of mounts.
11. Carefully align mount cover on mount base before applying even, downward pressure to snap cover into place. (Mount Covers can be damaged if the above process is not followed).
12. Attach 2-piece flairs to all posts. See step 12 of Standard (Level) Railing.

Swivel Stair Mount

1. Identify top, mid, and bottom rails, top mid and bottom stair swivel mounts.
2. Lay bottom rail (with approximately 1" clearance from the nose of the steps) beside the posts. Determine where the end holes will be on each end and place a baluster in those holes. Place top and mid rail on these balusters. Holding rails against posts, determine end spacing making sure end spacing is even between post and balusters. Clamp rails to post (Example 2). Hold swivel stair mounts up against posts and beside the rail to determine where rails are to be cut to fit inside the swivel stair

Swivel Stair Mount cont'd

mounts. Mark posts for each stair swivel mount position (Example 9). NOTE: This will vary depending on angle of stairs. Cut rails. Cut top rail at same length as mid and bottom rail unless using crossover railing.

3. Attach bottom swivel mount base so the bottom rail has approximately 1" clearance from the nose of the step. (NOTE: A 1" spacer may be placed on the nose of the step to reach the 1" clearance. Fasten base to post with pan head self-tapping screws (provided).
4. Attach top and mid rail swivel mount bases to post using pan head self-tapping screws (provided).
5. Follow Standard Stair Railing steps 6-12 for assembly of section.

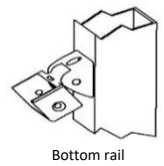
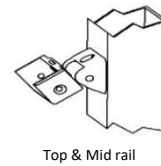
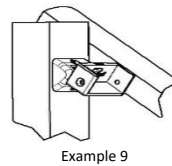

Care and Cleaning

Remove all particles and residue from Westbury aluminum components by referring to the Care and Cleaning requirements on the DSI website.



Warranty

For product Warranty and Registration please scan below:

