

Falcon Vinyl and "B" Series Railing



Installation Instructions

- It is the responsibility of the installer to meet all code and safety requirements, and to obtain all required building permits. The installer should determine and implement the installation techniques appropriate for each unique installation situation. Digger Specialties, Inc. and its distributors shall not be held liable for improper or unsafe installations.

Post Applications

Aluminum Post Mount for Concrete & Wood Applications:

If using a Standard Aluminum Post Mount (Residential) or Heavy-Duty Aluminum Post Mount (Commercial), see the instructions included with your mount.

4" x 4" Wood Support Posts:

Note: A 4" x 4" Vinyl Post does not have any structural strength to support weight bearing roofs.

A 4" x 4" wood treated post (which measures 3½" x 3½") will slide inside the vinyl post to support the weight. Most of the time, your posts are installed after the roof is in place. Usually, there is a beam the post can be attached to. Following are steps needed to install this post system. We do realize you can run into many different situations at the job site. In those cases, field modifications may be needed.

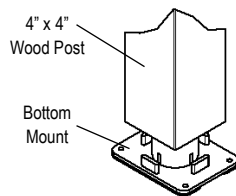

Step 1:

Cut vinyl post and wood post to size. To determine wood post length, stack (2) top/bottom support post mounts and measure distance between mounts and beam. To determine vinyl post length, measure distance between floor and beam and deduct 1". This will ensure no weight bearing on the vinyl post. NOTE: On wood make sure there is structural strength to support the weight of the roof.

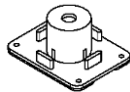

4" Support Post Mount

Step 2:

All material will need to be applied to the post before installation. Slide post flairs over top and bottom of post. Slide wood post inside vinyl post. Insert a post support mount on each end. The post support mount can be screwed to the wood post if desired (screws not included).

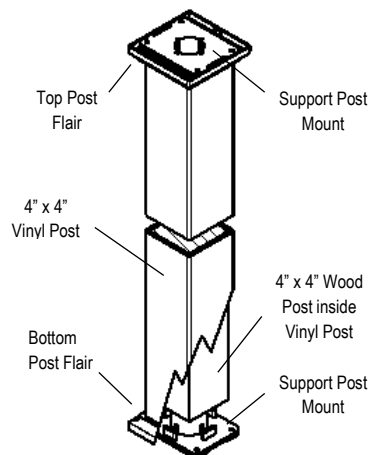

Step 3:

Slide post assembly into position. Insert (4) screws into each mount (screws not provided). Slide post flairs into position. Tabs will snap-lock into post support mounts. Flairs may be glued if desired (glue not included).

Post Applications cont'd

WARNING: Excess glue may run down post. Hold top flair in place until glue is cured.

4" x 4" Wood Support Posts - For Decks

Note: The strongest and least expensive way to apply a 4" x 4" vinyl post to a deck is to EXTEND your wood 4" x 4"s above the deck approximately 24".

Following are steps to use when building a frame deck or working with an existing wood structure.

Step 1:

When building a new deck and using 4" x 4" wood posts to support the wood structure, layout your post setting so it works out for both wood frame structure and length of railing sections you plan to install.

Step 2:

Set all wood posts leaving approximately 24" of the post(s) above determined height of floor or deck surface. NOTE: 24" of wood post is sufficient support for 36" or 42" vinyl railing systems. The higher the wood post is above the floor, the greater the chance for the wood post to warp.

If vinyl posts are desired below the floor joint, slide these posts on before the support board is attached. NOTE: These vinyl posts will go from the ground to the bottom of the joist support board.

Step 3:

After wood frame and deck flooring are installed, slide vinyl post over wood post. Slide post flair on at this time.

Option: Vinyl Posts on Existing Deck

When vinyl posts are to be attached to an existing wood deck and no wood posts are protruding above the deck floor, use an aluminum post mount (see instructions for wood surface) or install a 4" x 4" wood post as follows:

Step 1:

Cut a 4" x 4" hole in existing floor right inside joist support board. Install a wood 4" x 4" post to go to the bottom of the joist support board. This will extend above the deck floor approximately 24". Attach wood post with screws or bolts through support board and into wood post. After deck flooring is installed, slide vinyl post and flair over wood post.

Falcon Vinyl and "B" Series Railing



Installation Instructions

- It is the responsibility of the installer to meet all code and safety requirements, and to obtain all required building permits. The installer should determine and implement the installation techniques appropriate for each unique installation situation. Digger Specialties, Inc. and its distributors shall not be held liable for improper or unsafe installations.

Level Railing Applications

Step 1:

Hold each rail against posts. Position so there will be the same baluster spacing on each end of the rail. Mark top and bottom rails where they need to be cut. Cut rails to length. **NOTE: Make sure rails are cut with a 1/16" gap on each end between rails and posts.**

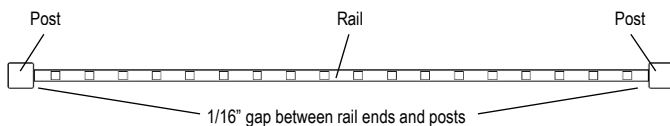

Step 2:

If installing a section 8' or longer, a railing support is required. It needs to be attached to the bottom rail at this time.

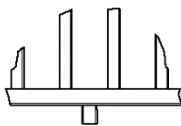

Railing Support

Vinyl: Find center of bottom rail. Insert screws into railing support and screw to bottom of rail. (Screws provided.)

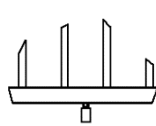

Railing Support

Aluminum "B Series": Find center of bottom rail. Insert screw into aluminum rail support and screw to bottom rail. Turn rail support to adjust height. (Screws provided.)

Step 3:

Slide a mount over each end of the rail (make sure profile side of mount is down). Place bottom rail in position. **NOTE: Leg of aluminum P-Channel needs to be facing inward.** Standard gap from floor is 2".

Center and screw mounts to post. If penetrating aluminum post use 1" self-tapping screws (provided); if used on vinyl post use 1 1/4" screws (provided). Insert (2) 3/4" self-tapping screws (provided) through location tabs to fasten rails to mount. **Important: Continue tightening until inside channel is drawn against inside of rail.**



Falcon Top Mount

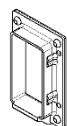

Falcon Bottom Mount

Insert vertical balusters into bottom rail holes. If there are notched balusters, they need to be placed in middle of the section. Position top rail into balusters one at a time. Position top rail between posts and fasten top mounts to post with screws (like bottom mount procedure).

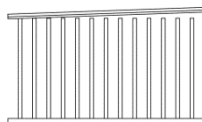

Assemble Rail Section

If using standard height posts, top rail should be 2" down (2 3/4" down if using an aluminum post mount) from top of post. Should a special height railing be required, the balusters and post may be cut down.

Level Railing Applications cont'd

Place mount covers over mounts. Tap each corner of cover to secure it to mount. **CAUTION: For bottom mount cover, line up top two corners of cover and LIGHTLY TAP the corners with a hammer. Then, carefully line up bottom of cover and LIGHTLY TAP with a hammer.**

Stair Rail Applications

NOTE: Make sure to review level railing applications before these steps are attempted. Stair rail mounts are needed for stair rail applications. Stair rail mounts are designed for up to a 35° application.

Step 1:

Lay the bottom rail on the steps and up against the posts. Determine the two end holes and insert a baluster at each end of rail. Place top rail on top of these two balusters. Holding rails against posts, determine exact end spacing, mark rails for cutting. If balusters are too tight and not level, make holes larger by filing out holes accordingly. Then, cut both rails at angle marks. Cut each end of the balusters at the same angle as top and bottom rails were cut. The overall length of balusters will not change.

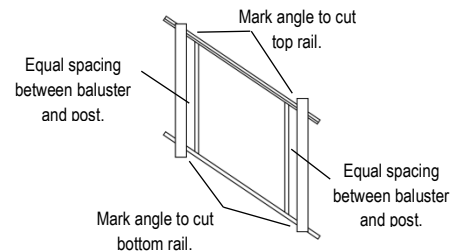

NOTE: Above ground application requires a 48" post at the bottom step. Field cut after railing is installed. The "A" Series Post must be cut off at the bottom before railing is installed. "A" Series Post length for bottom of steps - 48" for 36" railing and 52" for 42" railing

Step 2:

Slide a mount over each end of the rail (make sure profile side of mount is down, remove spacer from bottom mount). Place bottom rail in position. **NOTE: Leg of aluminum P-Channel needs to be facing inward.**

Center and screw mounts to post. If penetrating aluminum post use 1" self-tapping screws (provided); if used on vinyl post use 1 1/4" screws (provided). Insert (2) 3/4" self-tapping screws (provided) through location tabs to fasten rails to mount. Insert vertical balusters into bottom rail holes. Position top rail into balusters one at a time. Position top rail between posts and fasten top mounts to post with screws (like bottom mount procedure).

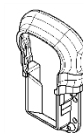

Falcon Stair Top Mount

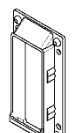

Falcon Stair Bottom Mount

Falcon Vinyl and "B" Series Railing



Installation Instructions

- It is the responsibility of the installer to meet all code and safety requirements, and to obtain all required building permits. The installer should determine and implement the installation techniques appropriate for each unique installation situation. Digger Specialties, Inc. and its distributors shall not be held liable for improper or unsafe installations.

Stair Rail Applications cont'd

If using standard height posts, top rail should be 2" down from top of post. Should a special height railing be required, the balusters and post may be cut down.

Place mount covers over mounts. Bottom cover has a knockout for a 32° to 35° angle (or may be cut out for varying angles). Tap each corner of cover to secure it to mount.

CAUTION: For bottom mount cover, line up top two corners of cover and **LIGHTLY TAP** the corners with a hammer. Then, carefully line up bottom of cover and **LIGHTLY TAP** with a hammer.

Top of top rails and bottom of bottom rails should match in height.

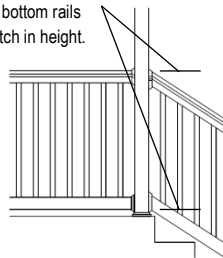

The top to bottom measurement should be the same for both the stair rail and the level rail sections.

Angle Applications cont'd

Side wall of mount may need to be cut out to accept the top portion of the top rail, depending on the angle.

Place mount covers over mounts. Tap each corner of cover to secure it to mount

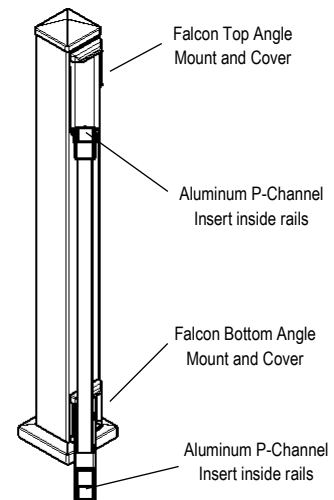

Angle Applications

NOTE: Make sure to review the level application installation before these steps are attempted. Angle mounts are needed for level application. These mounts can be cut to accept up to a 45° angle.

Step 1:

Cut rails to correct length, with angle cut to fit in between posts. Make sure rails are cut to have the same baluster spacing at each end of the rails. **NOTE:** Insert mounts on to rails ...before attaching to posts.

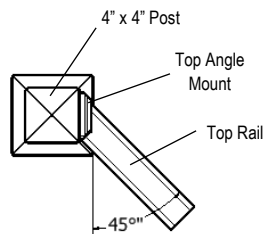

Step 2:

Bottom Mount...

Place mounts on rail. Insert (1) 3/4" self-tapping screw through location tab on bottom of mount (screws provided). This screw will go through both vinyl rail and aluminum P-channel insert. Place rail between posts. **NOTE:** Leg of aluminum P-Channel needs to be facing inward. Center and screw mounts to post with (4) 1 1/4" screws (screws provided). Screw (1) 3/4" screw through location tab on top of mount.

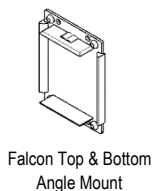

Top Mount...

Use same procedure as bottom mount except, predrill pilot hole on top of mount and rail.

Care and Cleaning

Remove all particles and residue from Vinyl components by referring to Care and Cleaning Requirements found at:



Warranty

For product Warranty and Registration please scan below:

