

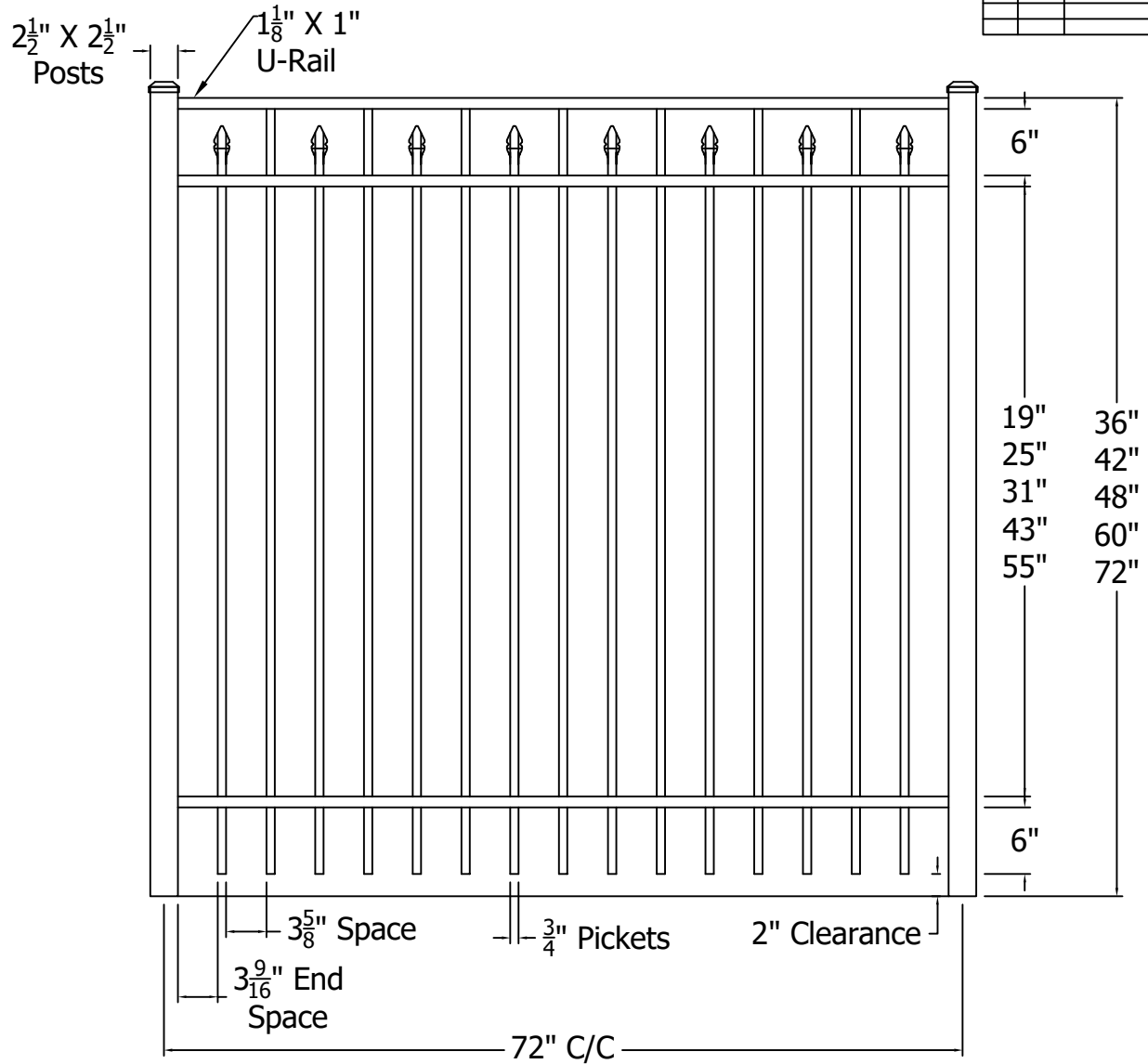





REV.	LOC.	REVISION	DATE



Finial Options	
 Quad	 Triad
 Fleur-de-lis	

	 <i>Transforming the Outdoor Living Experience™</i> 3446 US 6 EAST Bremen, IN 46506 diggerspecialties.com	DRAWN BY: EH	STYLE:
		DATE DRAWN: 03-15-2021	1233
		SCALE = 1":1"	AS SHOWN: 72" W 72" T
		DRAFT NO.: 20210315-1E	LOC: Z:\Aluminum\CourtYard\1000 Series\1000 SRS Sections\Updated Standard Drawings
			REV. A

4

3

2

1

D



C

B

A

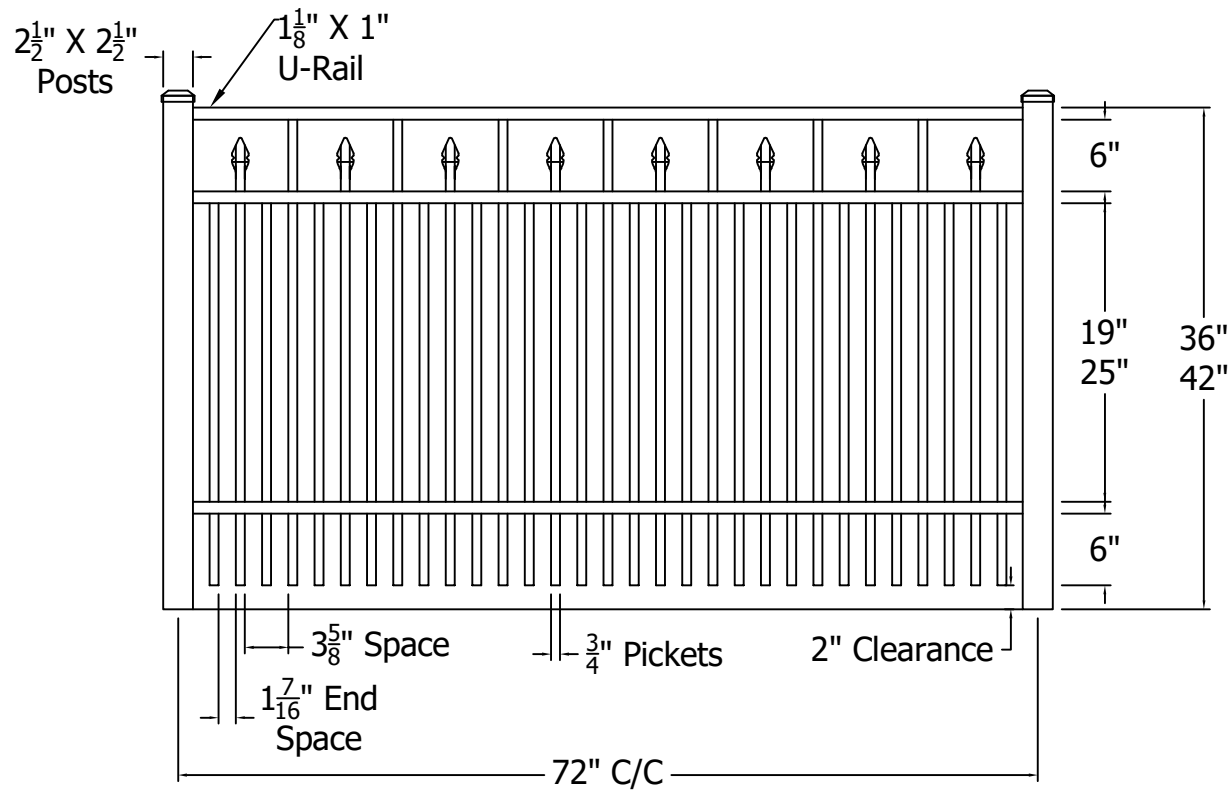
REV.	LOC.	REVISION	DATE



Finial Options	
 Quad	 Triad
 Fleur-de-lis	



DSI Digger Specialties Inc.
Transforming the Outdoor Living Experience™
 3446 US 6 EAST
 Bremen, IN 46506
 diggerspecialties.com

DRAWN BY: EH
 DATE DRAWN: 03-15-2021
 SCALE = 1":1"
 DRAFT NO.: 20210315-1E

STYLE:
1233 Short Picket Option
 AS SHOWN: 72" W 42" T
 LOC: Z:\Aluminum\CourtYard\1000 Series\1000 SRS Sections\Updated Standard Drawings
 REV. A

4

3

2

1

D



C

B

A

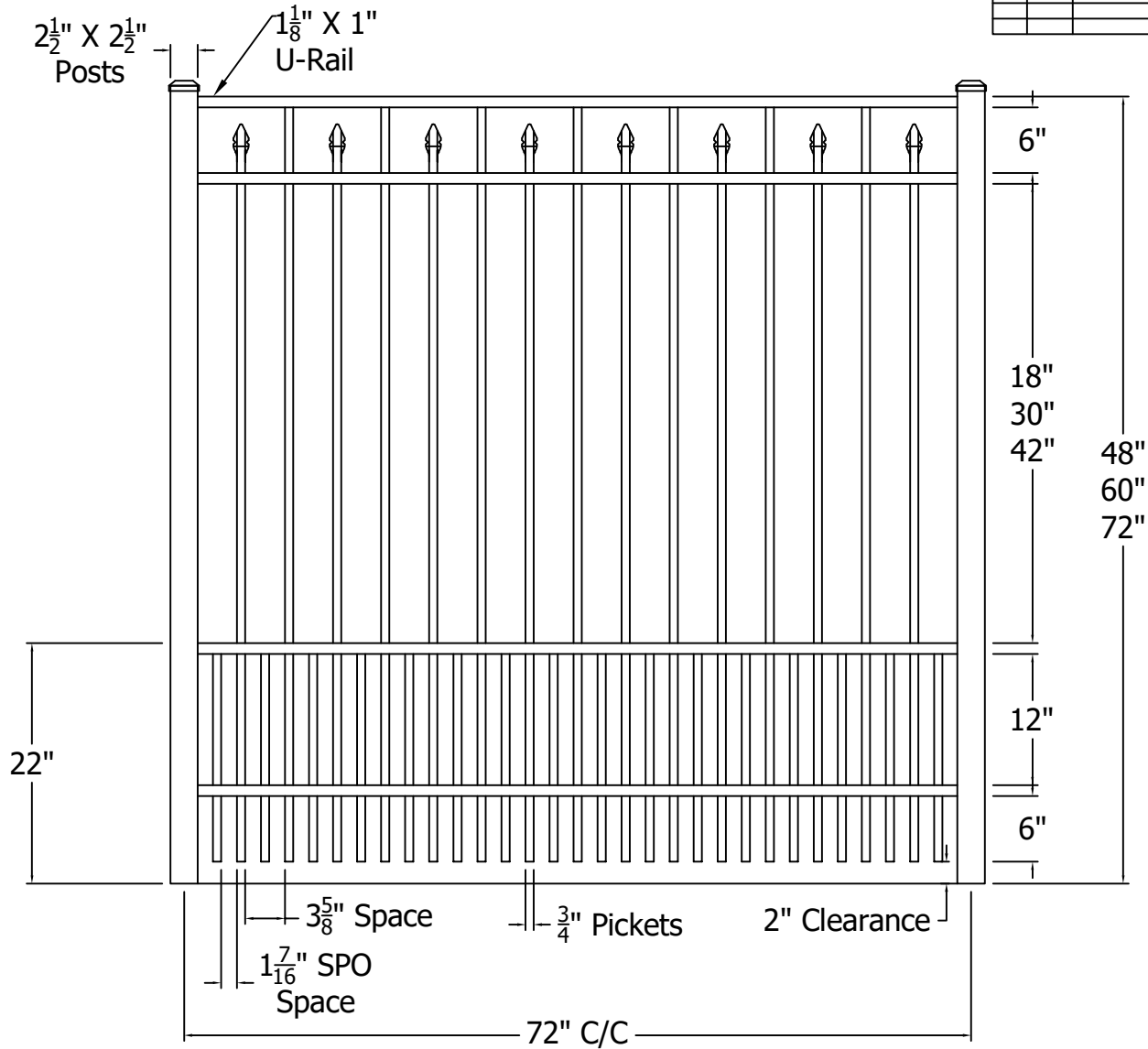
REV.	LOC.	REVISION	DATE



Finial Options	
 Quad	 Triad
 Fleur-de-lis	



DRAWN BY: EH	STYLE:	1233 Short Picket Option	REV. A
DATE DRAWN: 03-15-2021	AS SHOWN: 72" W 72" T		
SCALE = 1":1"	LOC: Z:\Aluminum\CourtYard\1000 Series\1000 SRS Sections\Updated Standard Drawings		
DRAFT NO.: 20210315-1E			

4

3

2

1

REV.	LOC.	REVISION	DATE

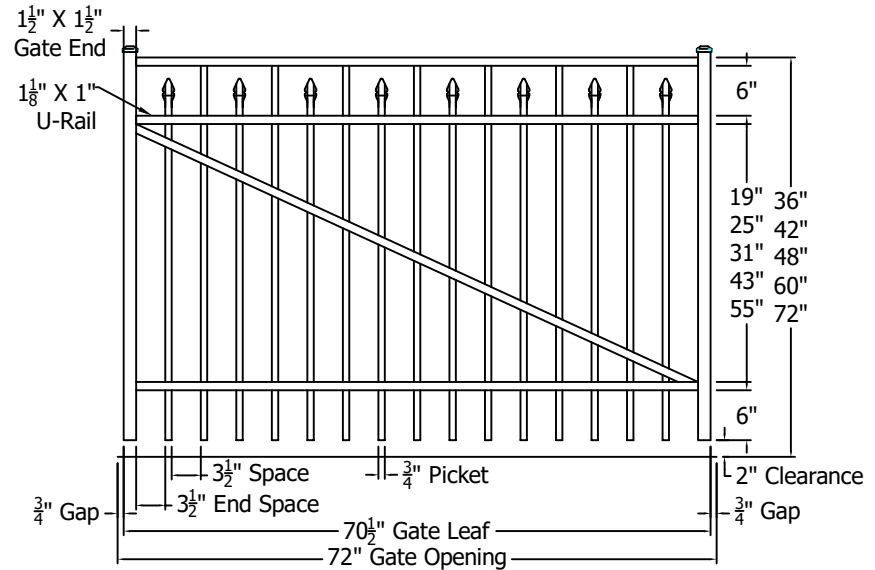
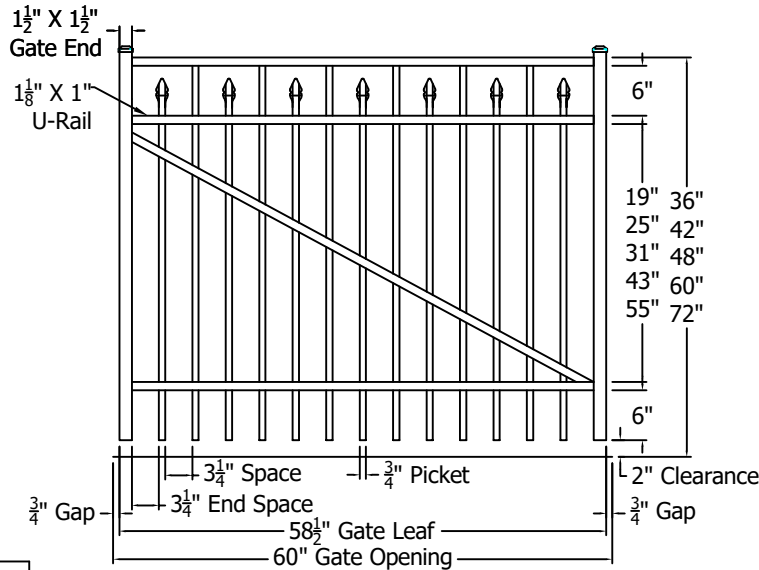
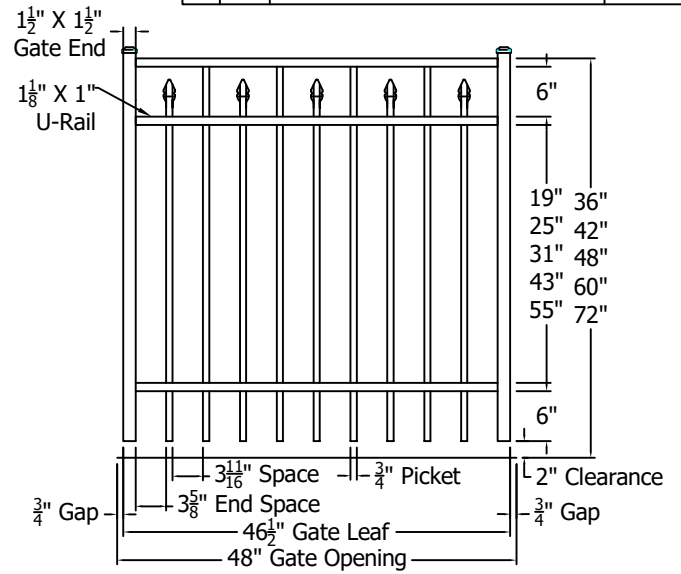
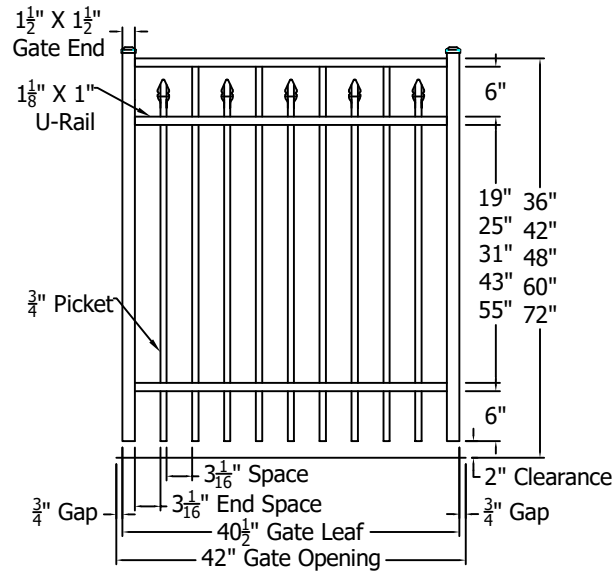
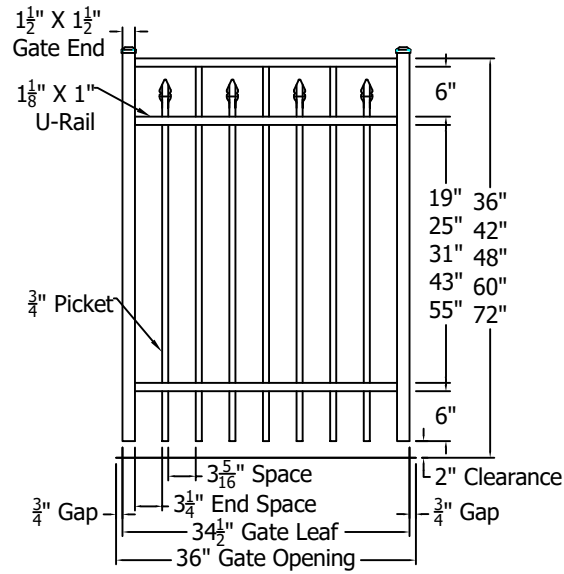

Finial Options	
Quad	Triad
Fleur-de-lis	

	<p>Transforming the Outdoor Living Experience™</p> <p>3446 US 6 EAST Bremen, IN 46506 diggerspecialties.com</p>	DRAWN BY: EH	STYLE:
		DATE DRAWN: 03-15-2021	1233 Standard Gates
		SCALE = 1":1"	AS SHOWN: 48" T
		DRAFT NO.: 20210315-1E	LOC: Z:\Aluminum\CourtYard\1000 Series\1000 SRS Gates\Updated Standard Drawings
			REV. A

4

3

2

1

D

C

B

A

REV.	LOC.	REVISION	DATE

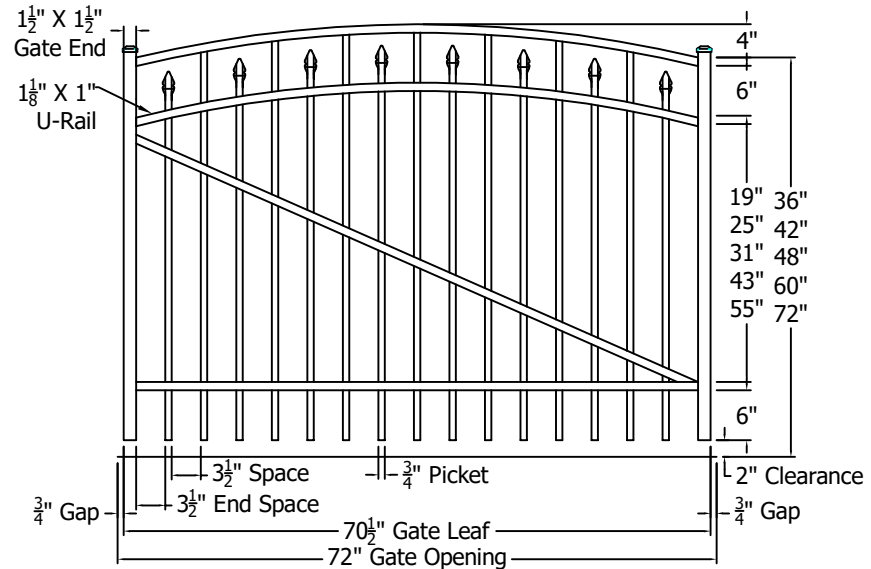
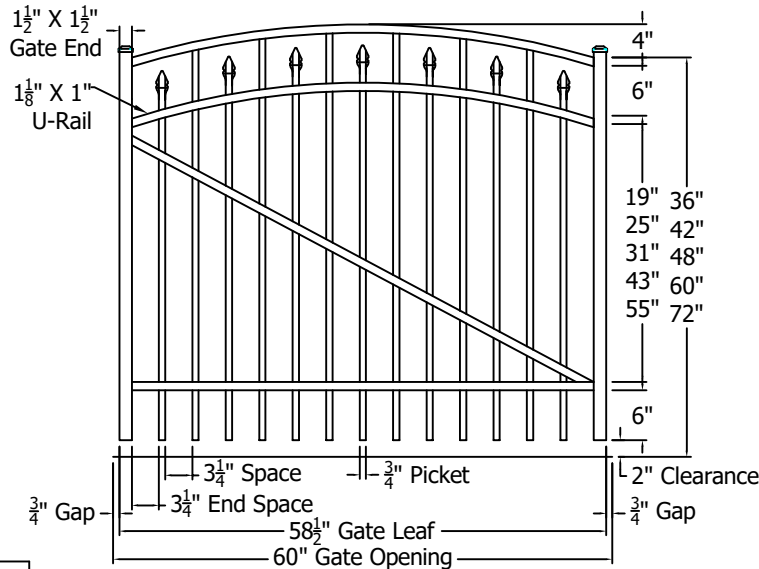
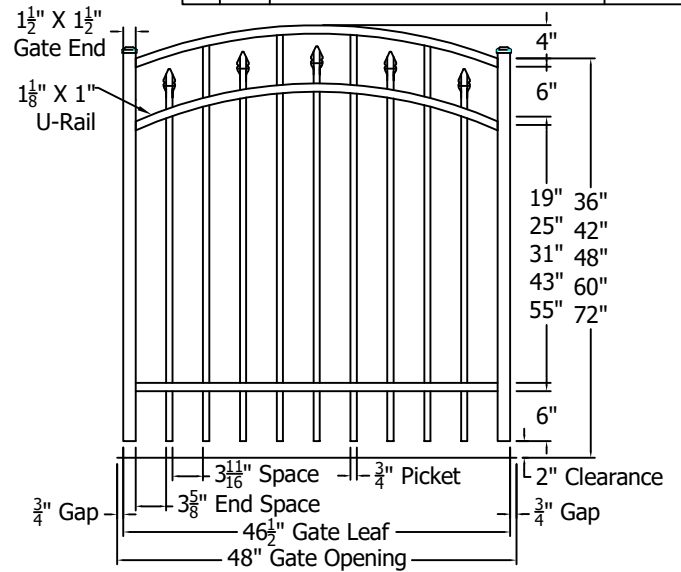
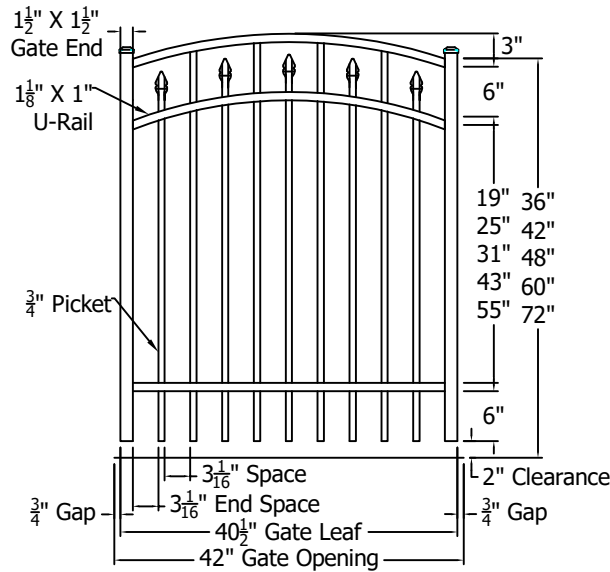
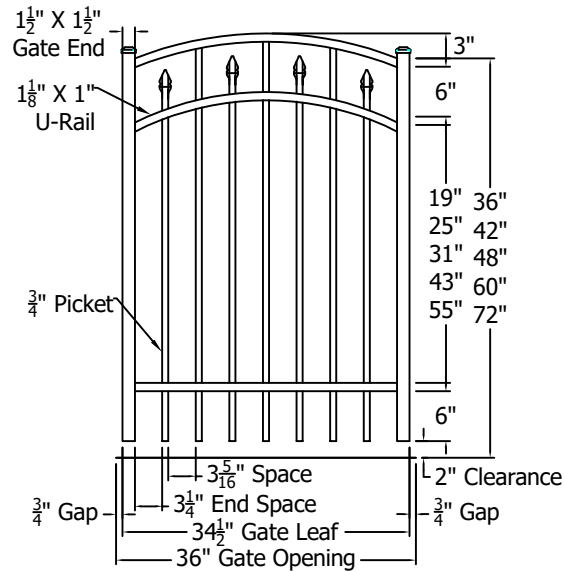

Finial Options	
Quad	Triad
Fleur-de-lis	

	<p>Transforming the Outdoor Living Experience™</p> <p>3446 US 6 EAST Bremen, IN 46506 diggerspecialties.com</p>	DRAWN BY: EH	STYLE:
		DATE DRAWN: 03-15-2021	1233 Standard Gates Arched
		SCALE = 1":1"	AS SHOWN: 48" T
		DRAFT NO.: 20210315-1E	LOC: Z:\Aluminum\CourtYard\1000 Series\1000 SRS Gates\Updated Standard Drawings
			REV. A

4

3

2

1

D

C



B

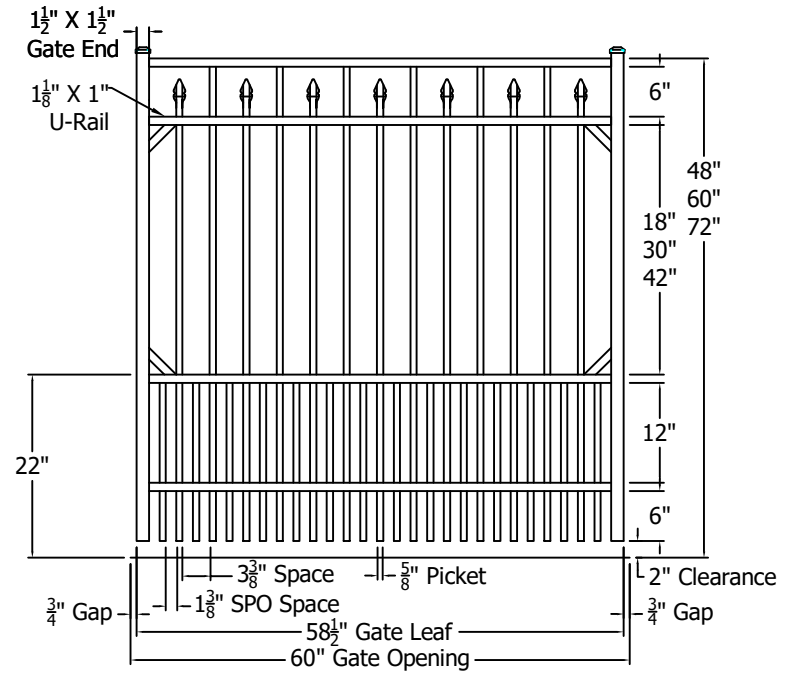
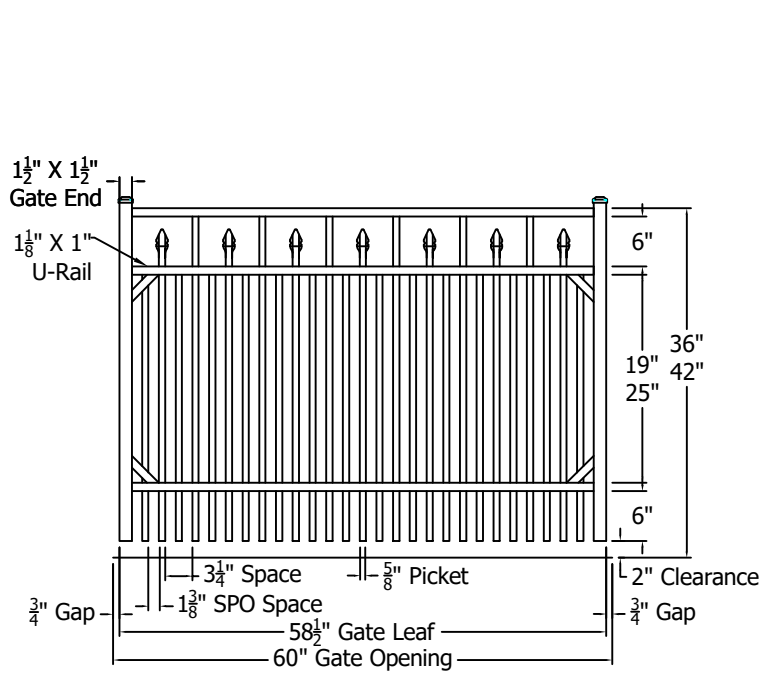

A

NOTE: Gusset Bracing Required On Gates Over 48" Wide

REV.	LOC.	REVISION	DATE



Finial Options	
 Quad	 Triad
 Fleur-de-lis	

	 Digger Specialties Inc. <i>Transforming the Outdoor Living Experience™</i> 3446 US 6 EAST Bremen, IN 46506 diggerspecialties.com	DRAWN BY: EH	STYLE:
		DATE DRAWN: 03-15-2021	1233 Standard Gates SPO
		SCALE = 1":1"	AS SHOWN: 48" T, 60" T
		DRAFT NO.: 20210315-1E	LOC: Z:\Aluminum\CourtYard\1000 Series\1000 SRS Gates\Updated Standard Drawings
			REV. A

4

3

2

1

D

C

B

A