

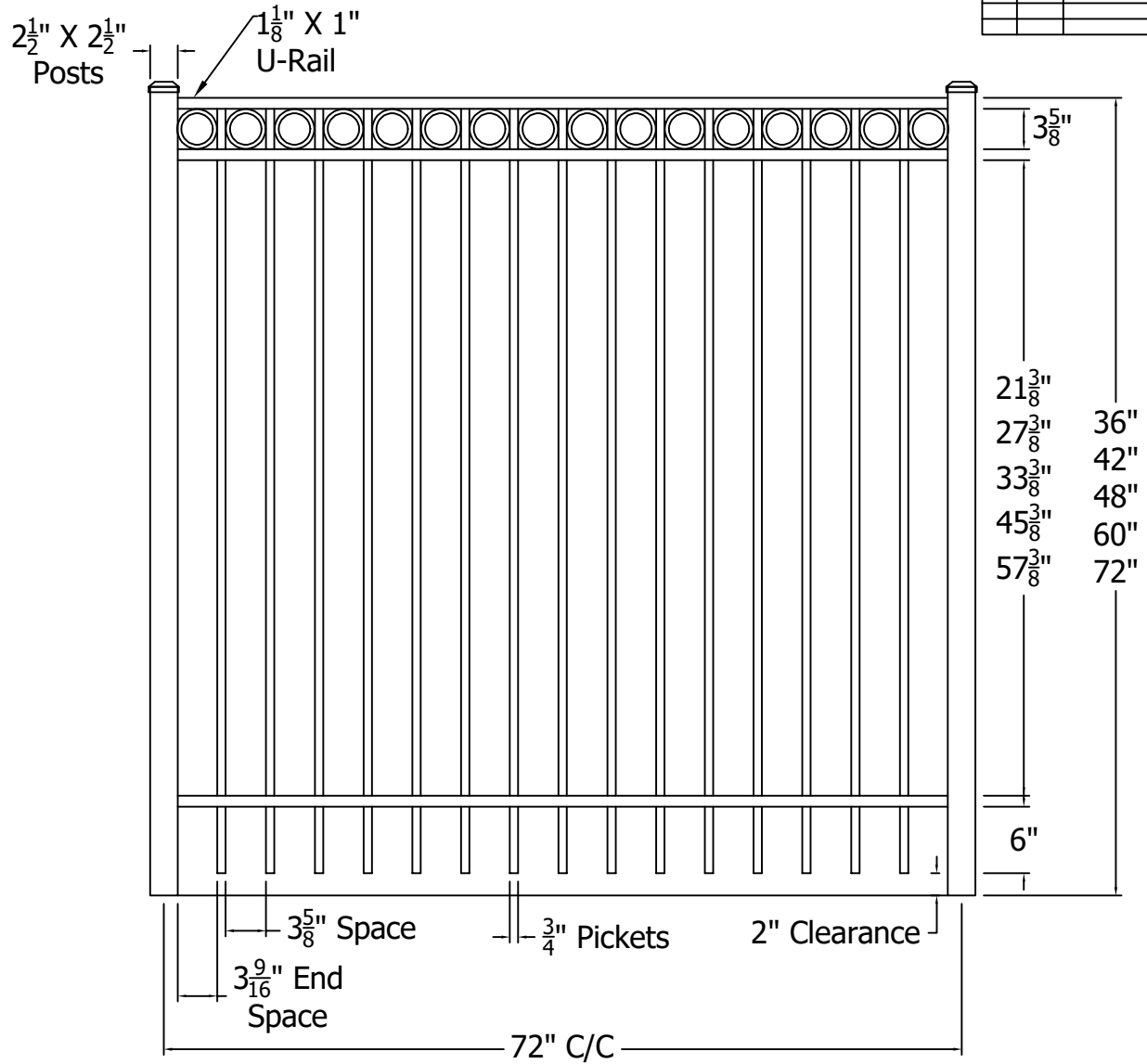

REV.	LOC.	REVISION	DATE



	 <p>3446 US 6 EAST Bremen, IN 46506 diggerspecialties.com</p>	DRAWN BY: EH	STYLE:
		DATE DRAWN: 03-08-2021	<b>1230R</b>
SCALE = 1":1"		AS SHOWN: 72" W 72" T	
DRAFT NO.: 20210308-1E	LOC: Z:\Aluminum\CourtYard\1000 Series\1000 SRS Sections\Updated Standard Drawings	REV.	<b>A</b>

4

3

2

1

D



C

B

A

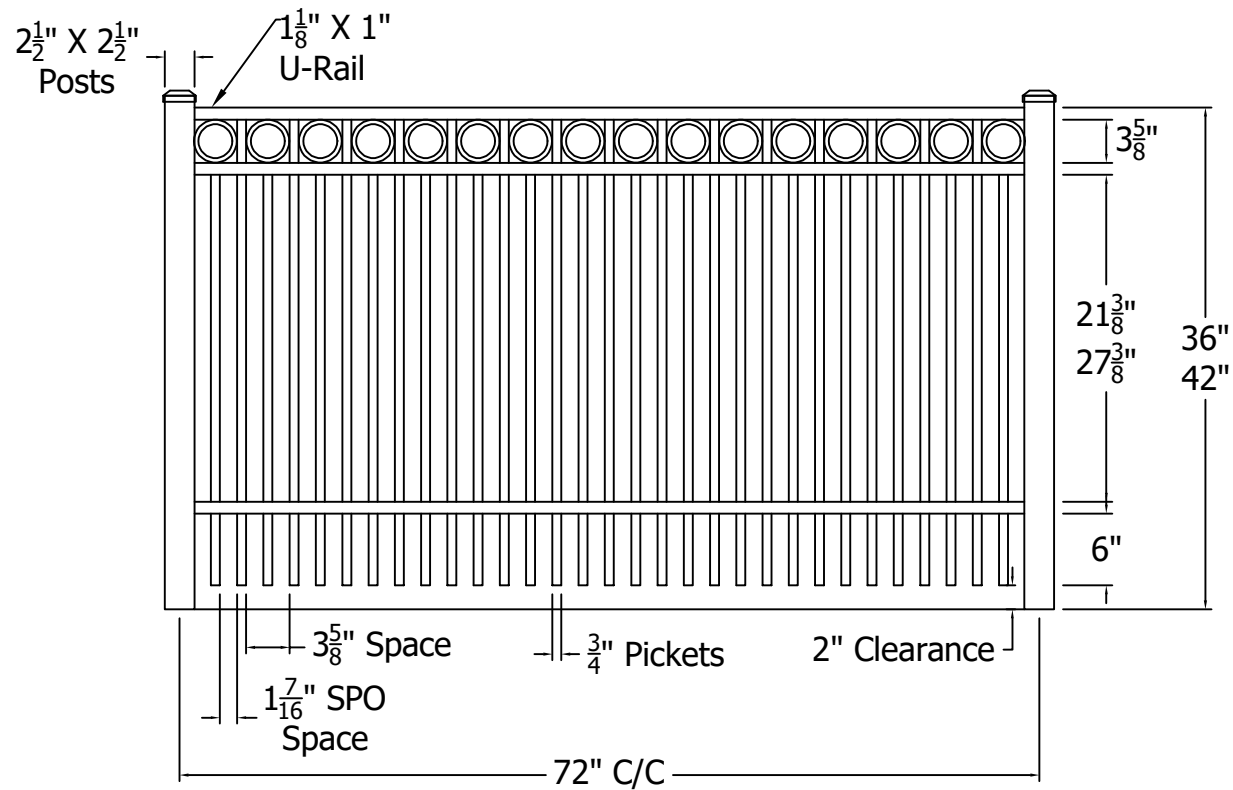
REV.	LOC.	REVISION	DATE



	 <p>3446 US 6 EAST Bremen, IN 46506 diggerspecialties.com</p>	DRAWN BY: EH DATE DRAWN: 03-08-2021	STYLE: <b>1230R Short Picket Option</b>
		SCALE = 1":1" DRAFT NO.: 20210308-1E	AS SHOWN: 72" W 42" T LOC: Z:\Aluminum\CourtYard\1000 Series\1000 SRS Sections\Updated Standard Drawings
		REV. A	

4



3

2

1

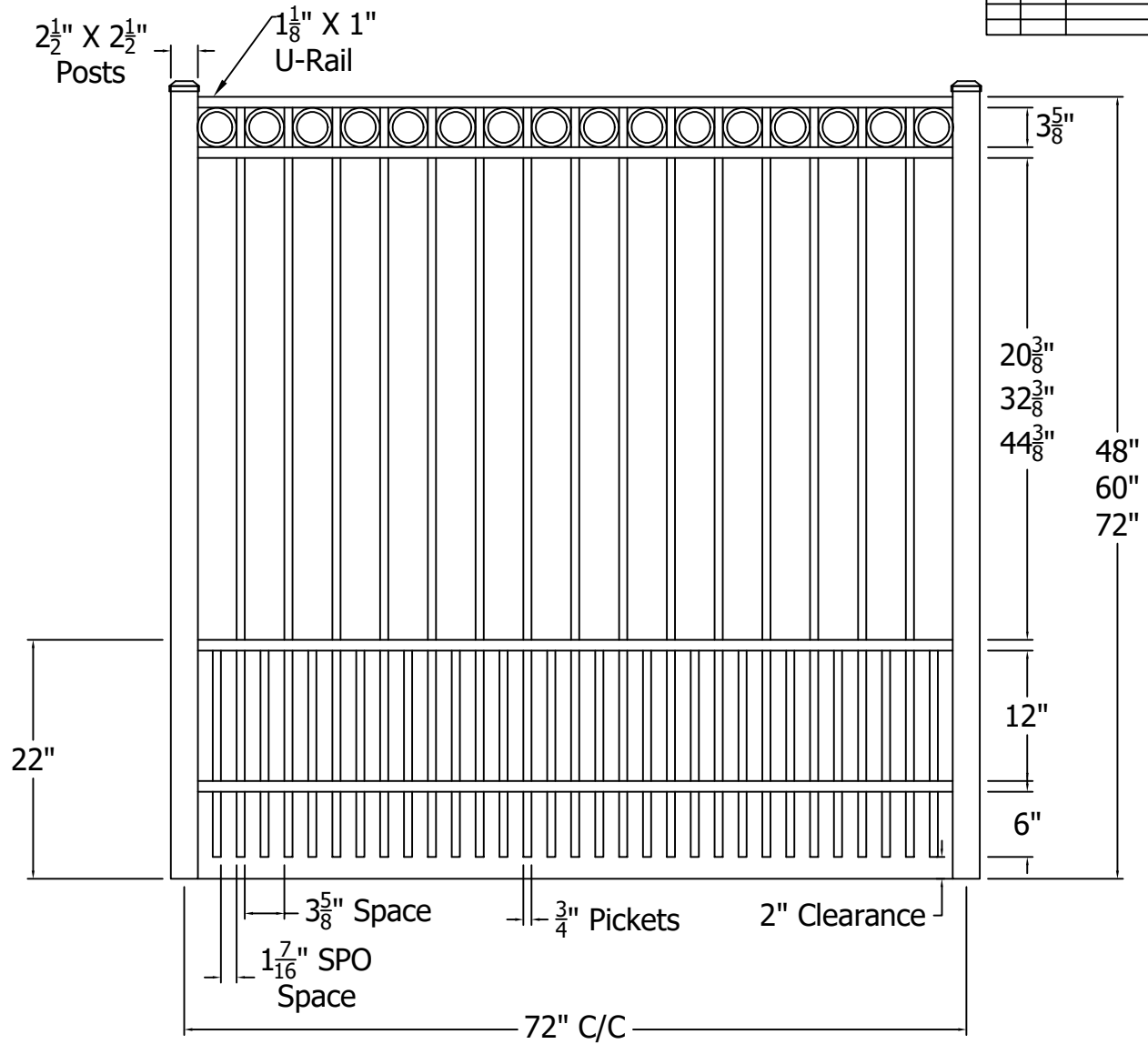
REV.	LOC.	REVISION	DATE



	 <p>3446 US 6 EAST Bremen, IN 46506 diggerspecialties.com</p>	DRAWN BY: EH DATE DRAWN: 03-08-2021	STYLE: <b>1230R Short Picket          Option</b>
		SCALE = 1":1"	AS SHOWN: 72" W 72" T
		DRAFT NO.: 20210308-1E	LOC: Z:\Aluminum\CourtYard\1000 Series\1000 SRS Sections\Updated Standard Drawings
		REV. <b>A</b>	

4

3

2

1

D



C

B

A

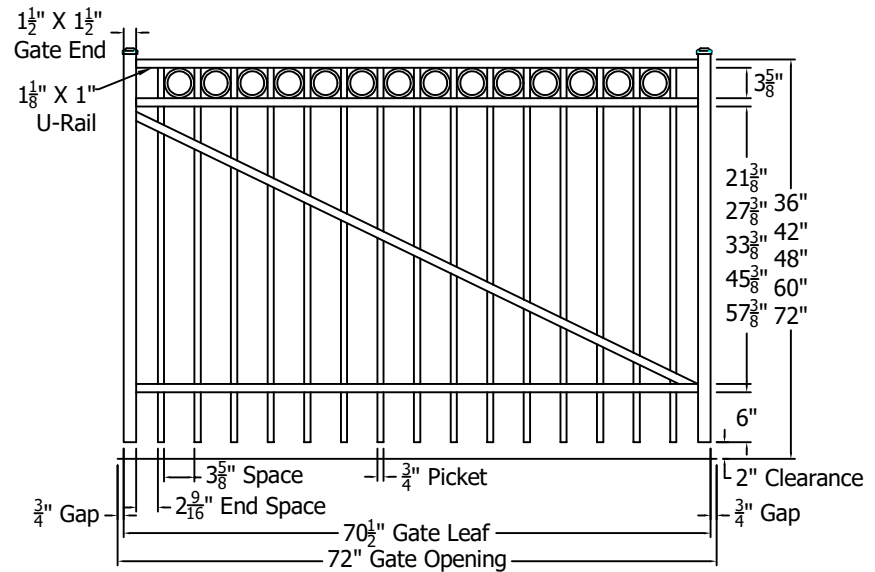
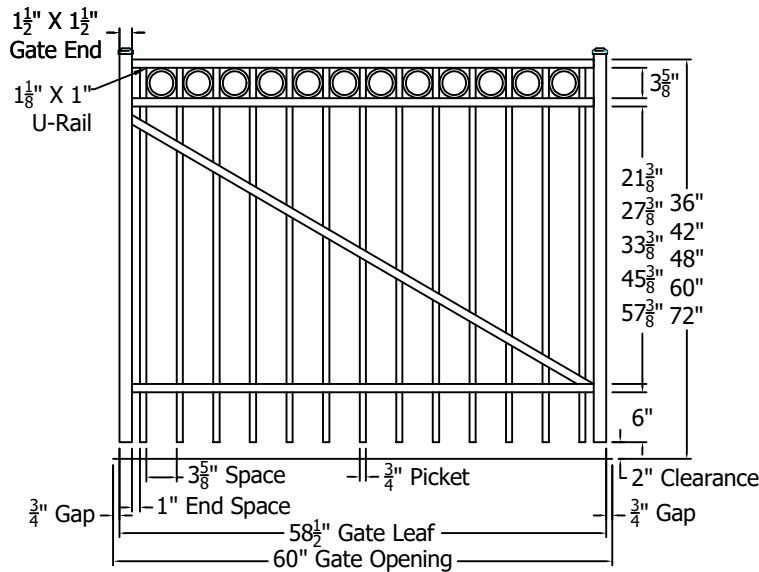
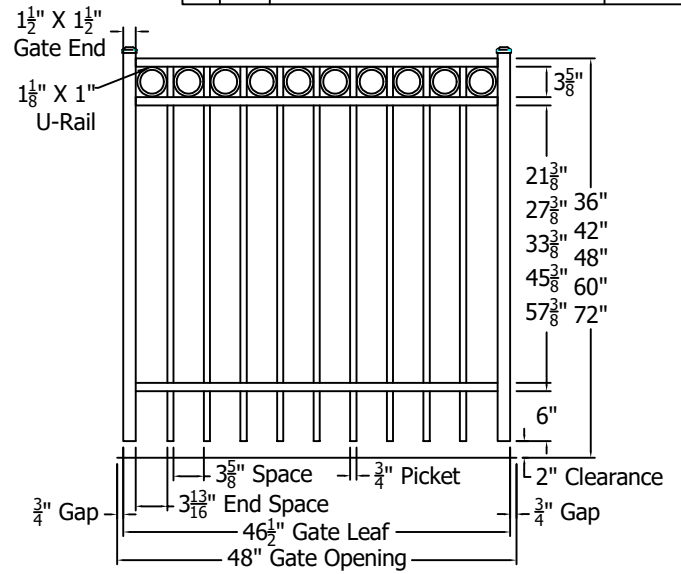
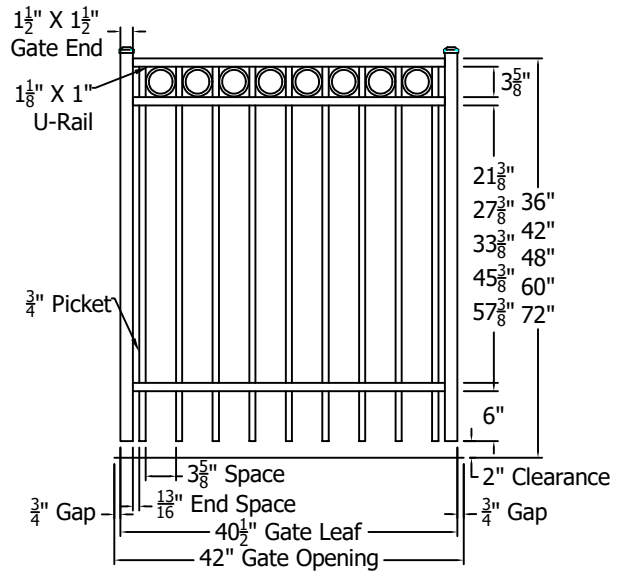
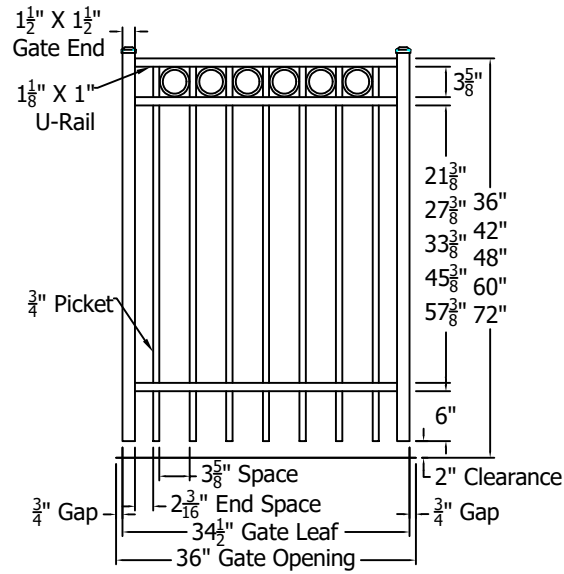
REV.	LOC.	REVISION	DATE



	 <p>3446 US 6 EAST Bremen, IN 46506 diggerspecialties.com</p>	DRAWN BY: EH DATE DRAWN: 03-08-2021	STYLE: <b>1230R Standard Gates</b>
		SCALE = 1":1" DRAFT NO.: 20210308-1E	AS SHOWN: 48" T LOC: Z:\Aluminum\CourtYard\1000 Series\1000 SRS Gates\Updated Standard Drawings
			REV. <b>A</b>

4

3

2

1

D

C

B

A