

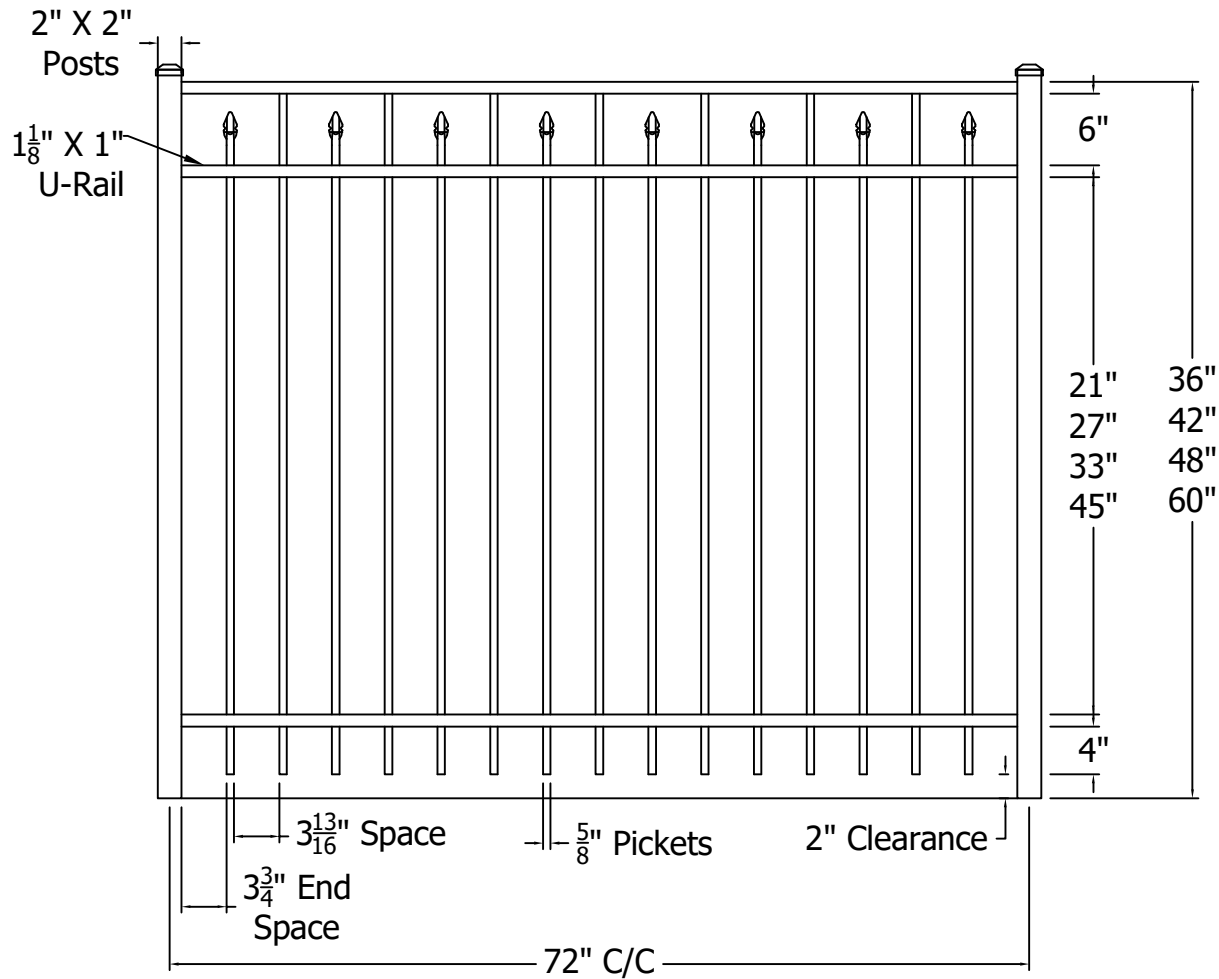



REV.	LOC.	REVISION	DATE



Finial Options	
 Quad	 Triad
 Fleur-de-lis	



DRAWN BY: EH	STYLE:	<b>0233</b>
DATE DRAWN: 02-18-2021		
SCALE = 1":1"	AS SHOWN: 72" W 60" T	
DRAFT NO.: 20210218-1E	LOC: Z:\Aluminum\CourtYard\Hundred Series\Hundred SRS Sections\Updated Standard Drawings	REV. <b>A</b>

4

3

2

1

D



C

B

A

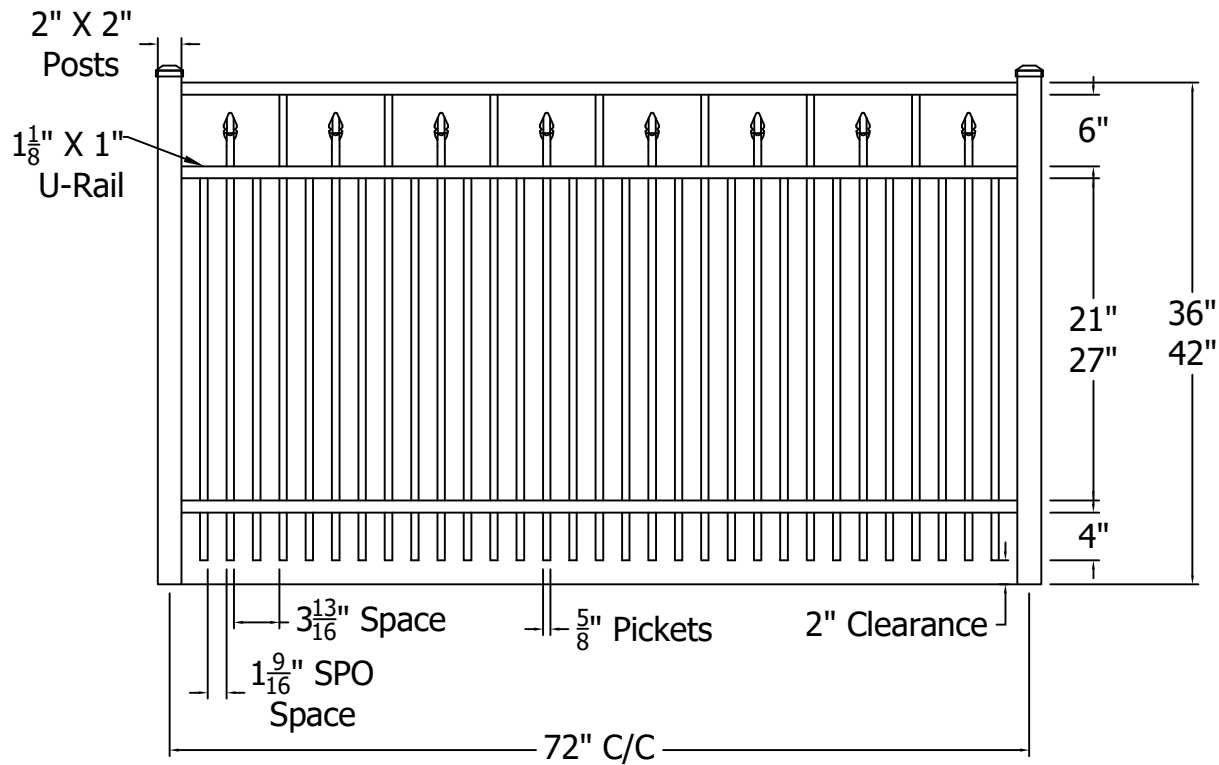
REV.	LOC.	REVISION	DATE



Finial Options	
 Quad	 Triad
 Fleur-de-lis	



**DSI** Digger Specialties Inc.  
*Transforming the Outdoor Living Experience™*  
 3446 US 6 EAST  
 Bremen, IN 46506  
 diggerspecialties.com

DRAWN BY: EH  
 DATE DRAWN: 02-18-2021  
 SCALE = 1":1"  
 DRAFT NO.: 20210218-1E

STYLE:  
**0233 Short Picket Option**  
 AS SHOWN: 72" W 42" T  
 LOC: Z:\Aluminum\CourtYard\Hundred Series\Hundred SRS Sections\Updated Standard Drawings  
 REV. A

4

3

2

1

D



C

B

A

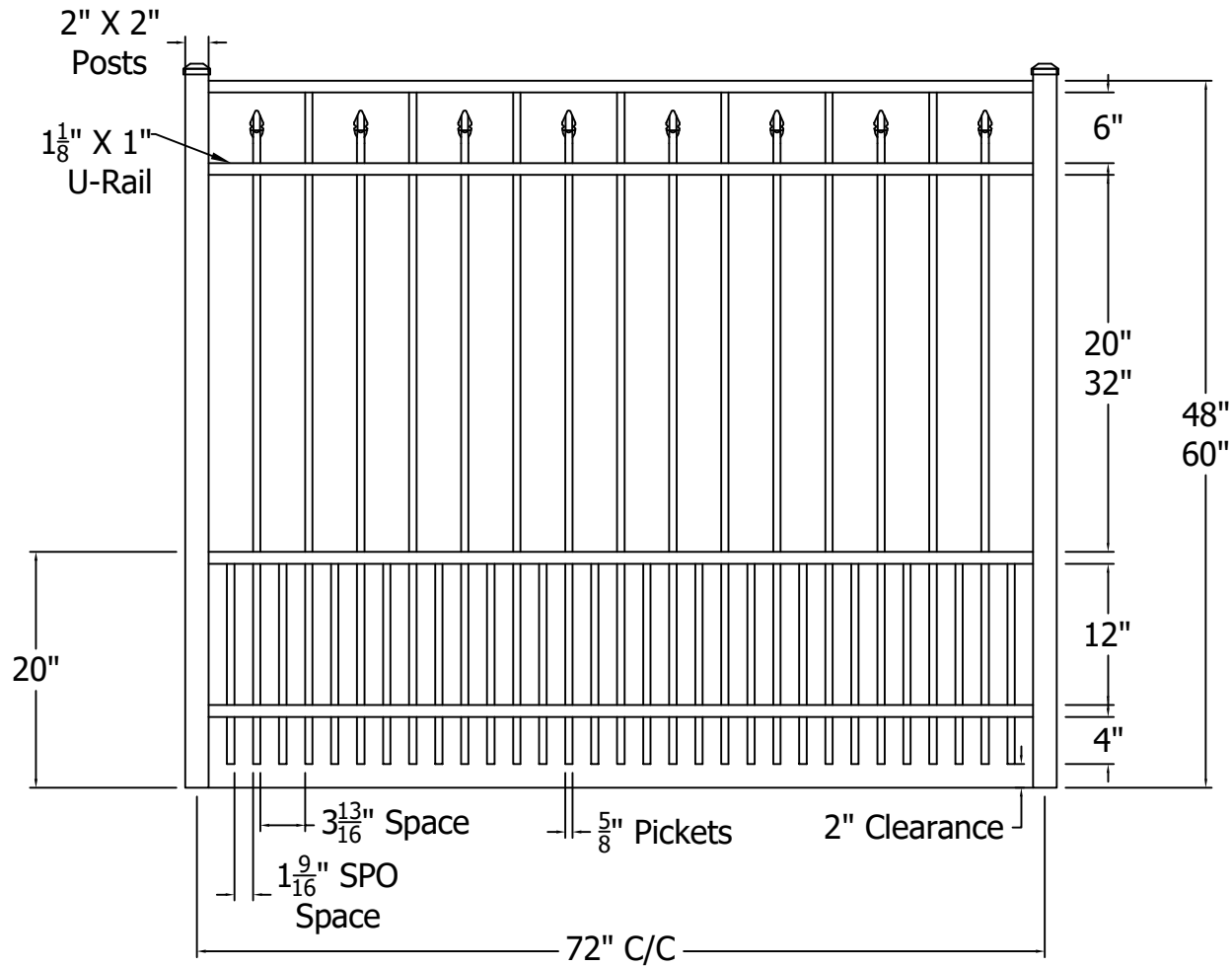
REV.	LOC.	REVISION	DATE



Finial Options	
 Quad	 Triad
 Fleur-de-lis	



DRAWN BY: EH	STYLE:	<b>0233 Short Picket Option</b>	REV. A
DATE DRAWN: 02-18-2021	AS SHOWN: 72" W 60" T		
SCALE = 1":1"	LOC: Z:\Aluminum\CourtYard\Hundred Series\Hundred SRS Sections\Updated Standard Drawings		
DRAFT NO.: 20210218-1E			

4

3

2

1

D

C

B

A

REV.	LOC.	REVISION	DATE

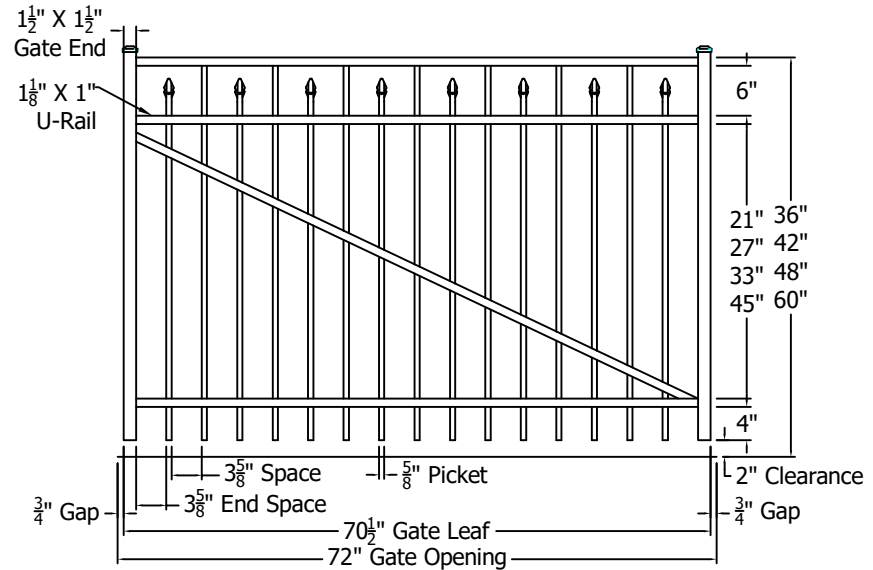
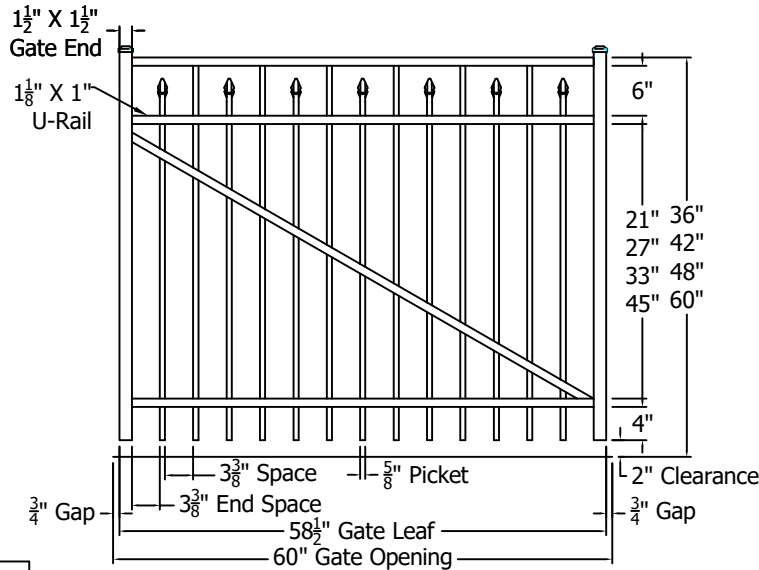
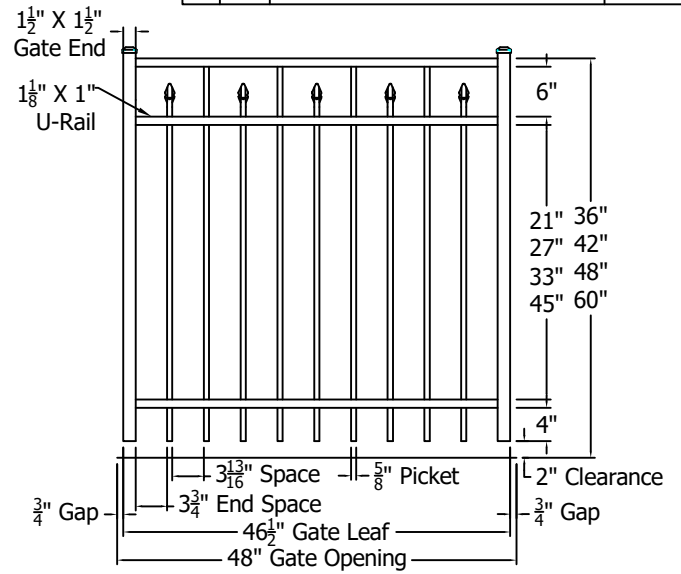
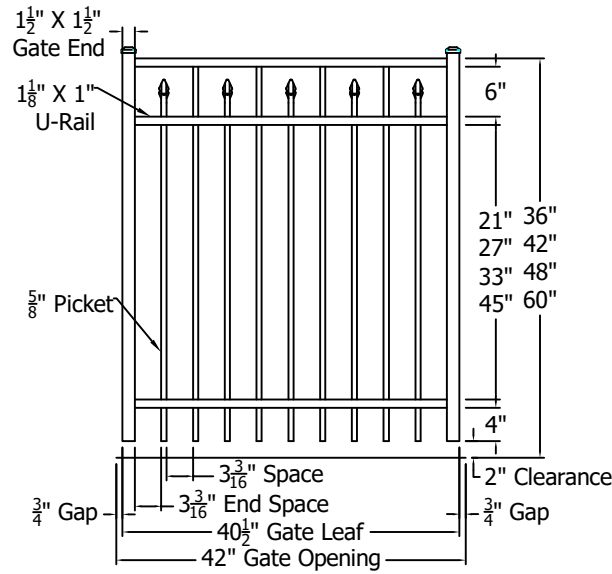
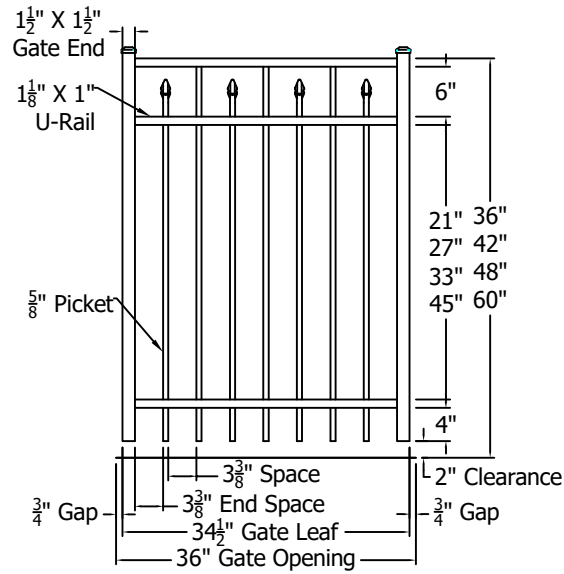

Finial Options	
Quad	Triad
Fleur-de-lis	

	<p>3446 US 6 EAST Bremen, IN 46506 diggerspecialties.com</p>	DRAWN BY: EH	STYLE:
		DATE DRAWN: 02-18-2021	<b>0233 Standard Gates</b>
		SCALE = 1":1"	AS SHOWN: 48" T
		DRAFT NO.: 20210218-1E	LOC: Z:\Aluminum\CourtYard\Hundred Series\Hundred SRS Gates
		REV.	A

4

3

2

1

D

C

B

A

REV.	LOC.	REVISION	DATE

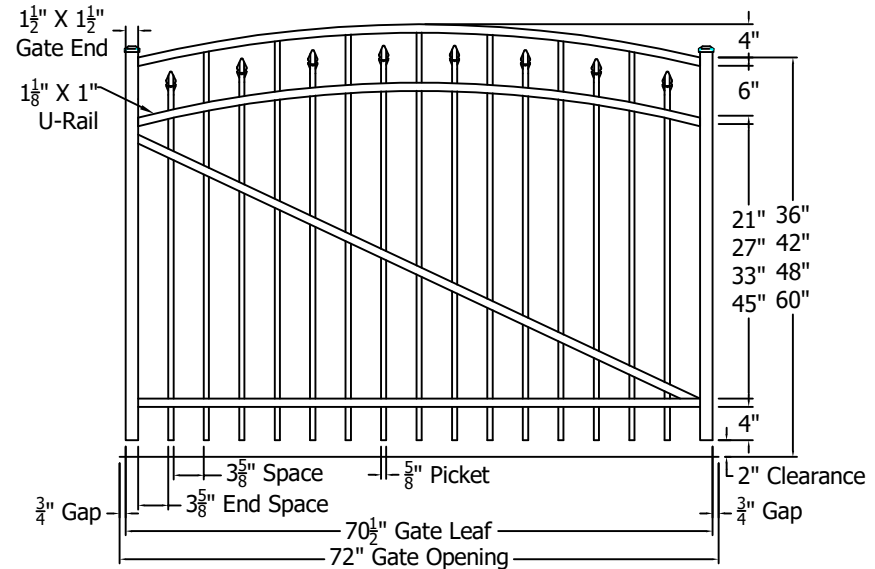
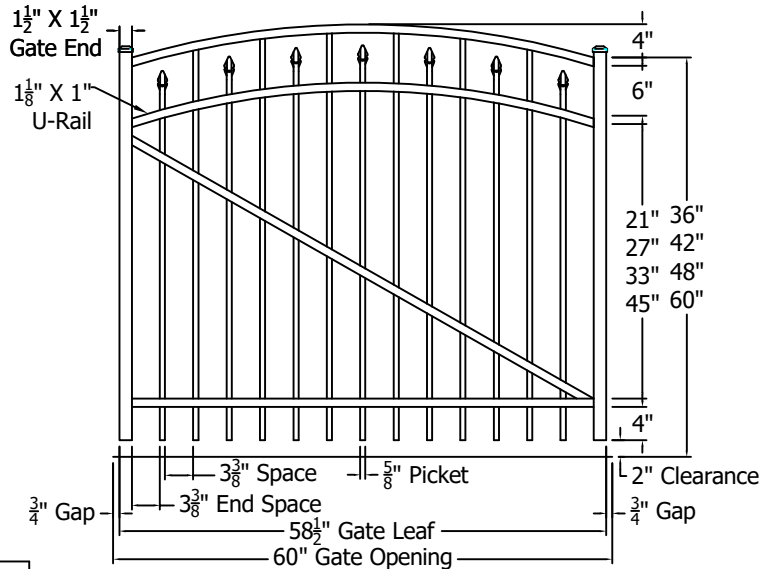
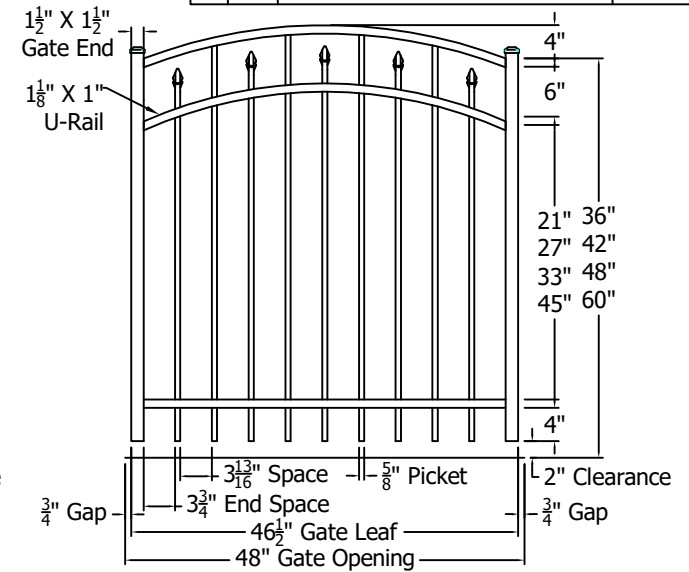
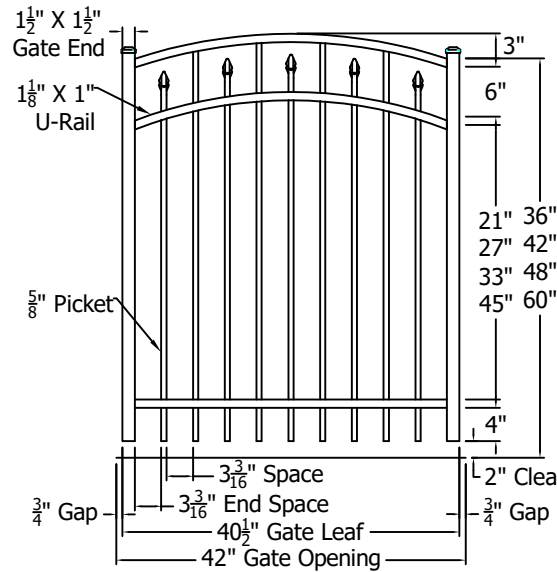
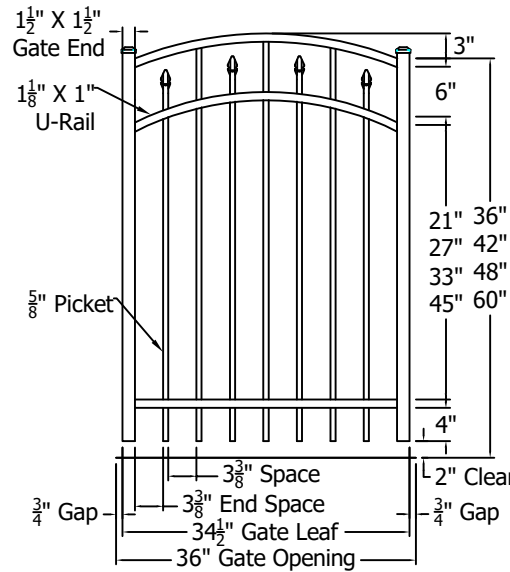

Finial Options	
Quad	Triad
Fleur-de-lis	

 CourtYard® ALUMINUM FENCING	 DSI Digger Specialties Inc. <i>Transforming the Outdoor Living Experience™</i> 3446 US 6 EAST Bremen, IN 46506 diggerspecialties.com	DRAWN BY: EH DATE DRAWN: 02-18-2021	STYLE: <b>0233 Standard Gates Arched</b>
		SCALE = 1":1"	AS SHOWN: 48" T
		DRAFT NO.: 20210218-1E	LOC: Z:\Aluminum\CourtYard\Hundred Series\Hundred SRS Gates
		REV. A	REV. A

4

3

2

1

D

C



B

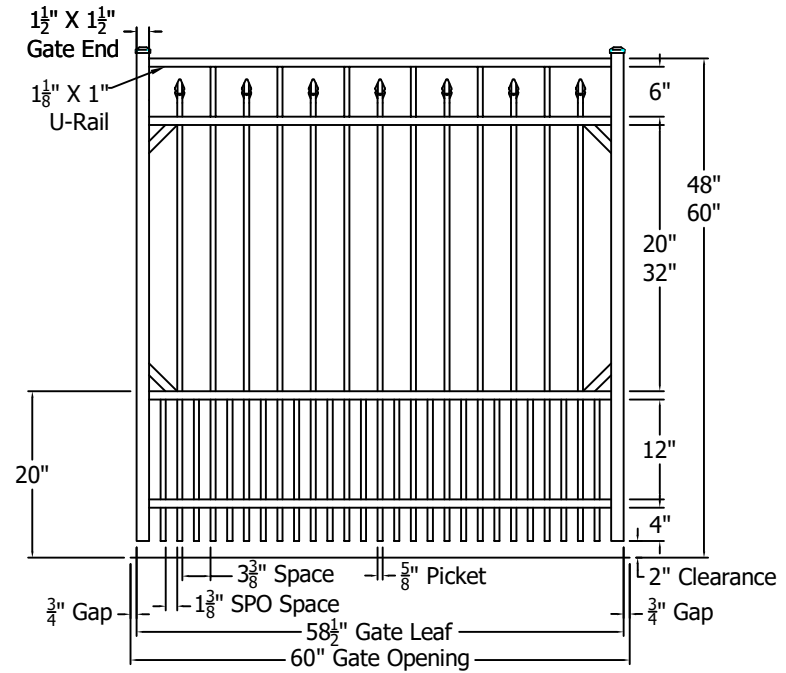
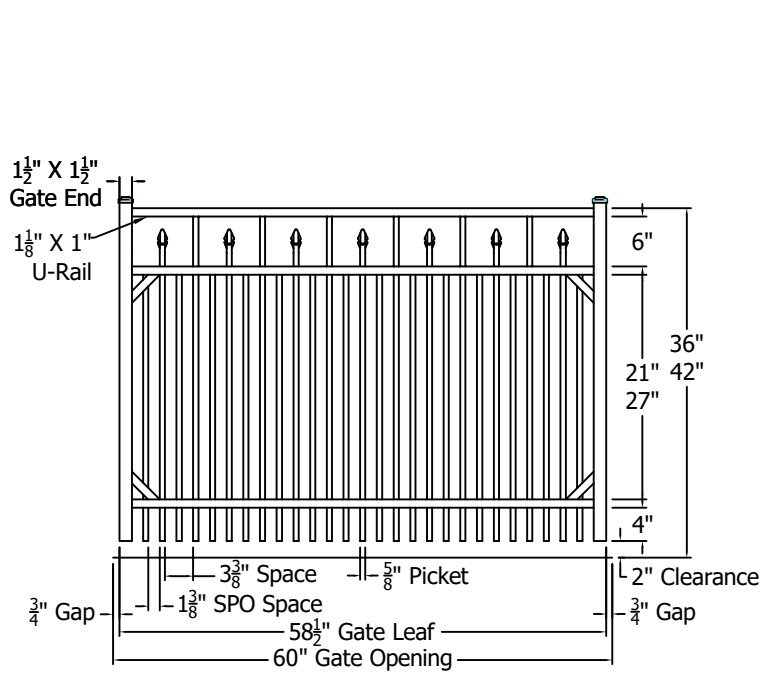

A

NOTE: Gusset Bracing Required On Gates Over 48" Wide

REV.	LOC.	REVISION	DATE



Finial Options	
 Quad	 Triad
 Fleur-de-lis	

	 Digger Specialties Inc. <i>Transforming the Outdoor Living Experience™</i> 3446 US 6 EAST Bremen, IN 46506 diggerspecialties.com	DRAWN BY: EH	STYLE:
		DATE DRAWN: 02-18-2021	<b>0233 Standard Gates SPO</b>
		SCALE = 1":1"	AS SHOWN: 42" T, 60" T
		DRAFT NO.: 20210218-1E	LOC: Z:\Aluminum\CourtYard\Hundred Series\Hundred SRS Gates
			REV. A

4

3

2

1

D

C

B

A