

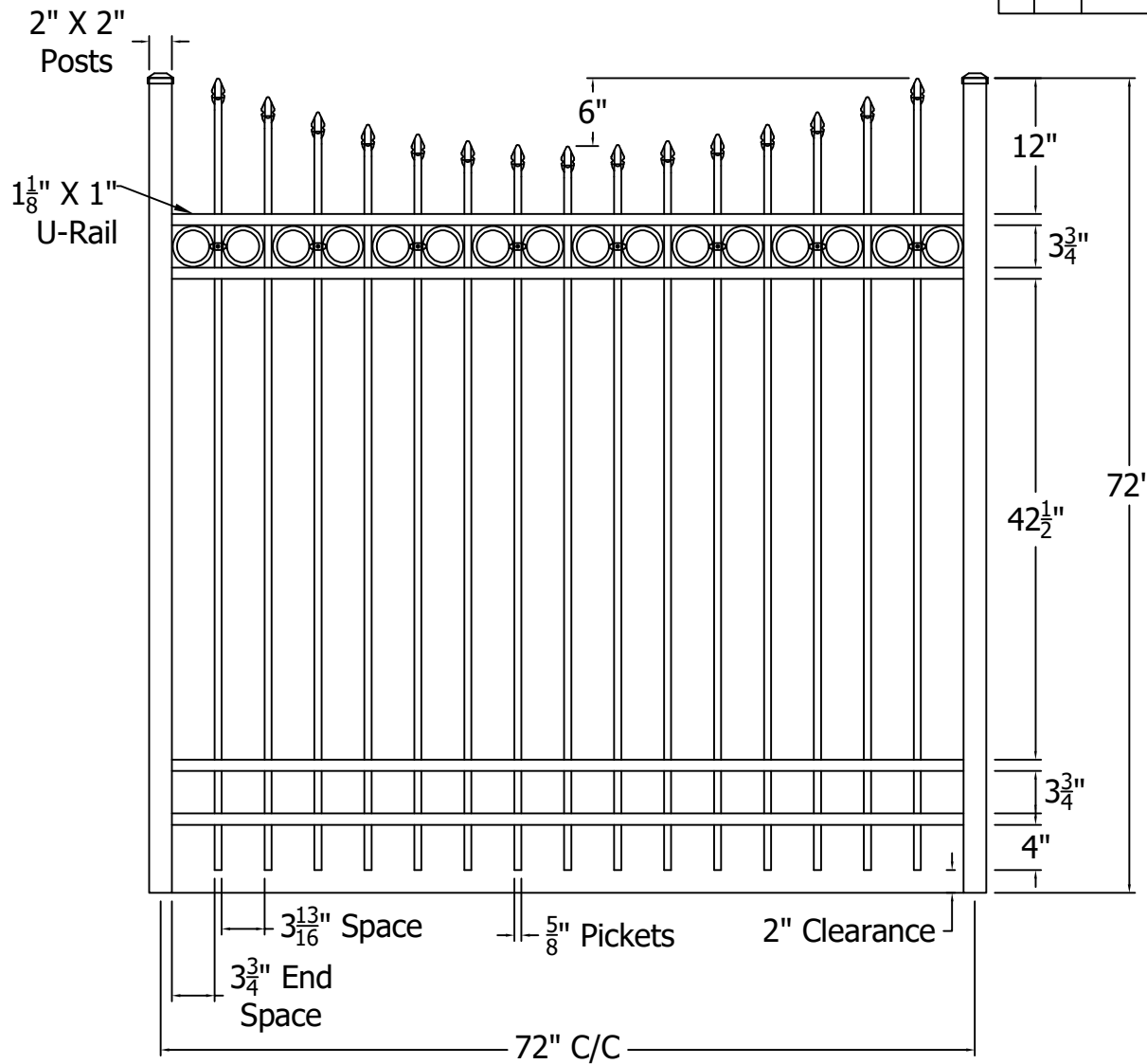



REV.	LOC.	REVISION	DATE



Finial Options	
 Quad	 Triad
 Fleur-de-lis	



DRAWN BY: EH	STYLE:	<b>0141R Concave</b>	REV. <b>A</b>
DATE DRAWN: 01-18-2021			
SCALE = 1":1"	AS SHOWN: 72" T		
DRAFT NO.: 20210118-1E	LOC: Z:\Aluminum\CourtYard\Hundred Series\Hundred SRS Sections\Updated Standard Drawings		

4

3

2

1

D



C

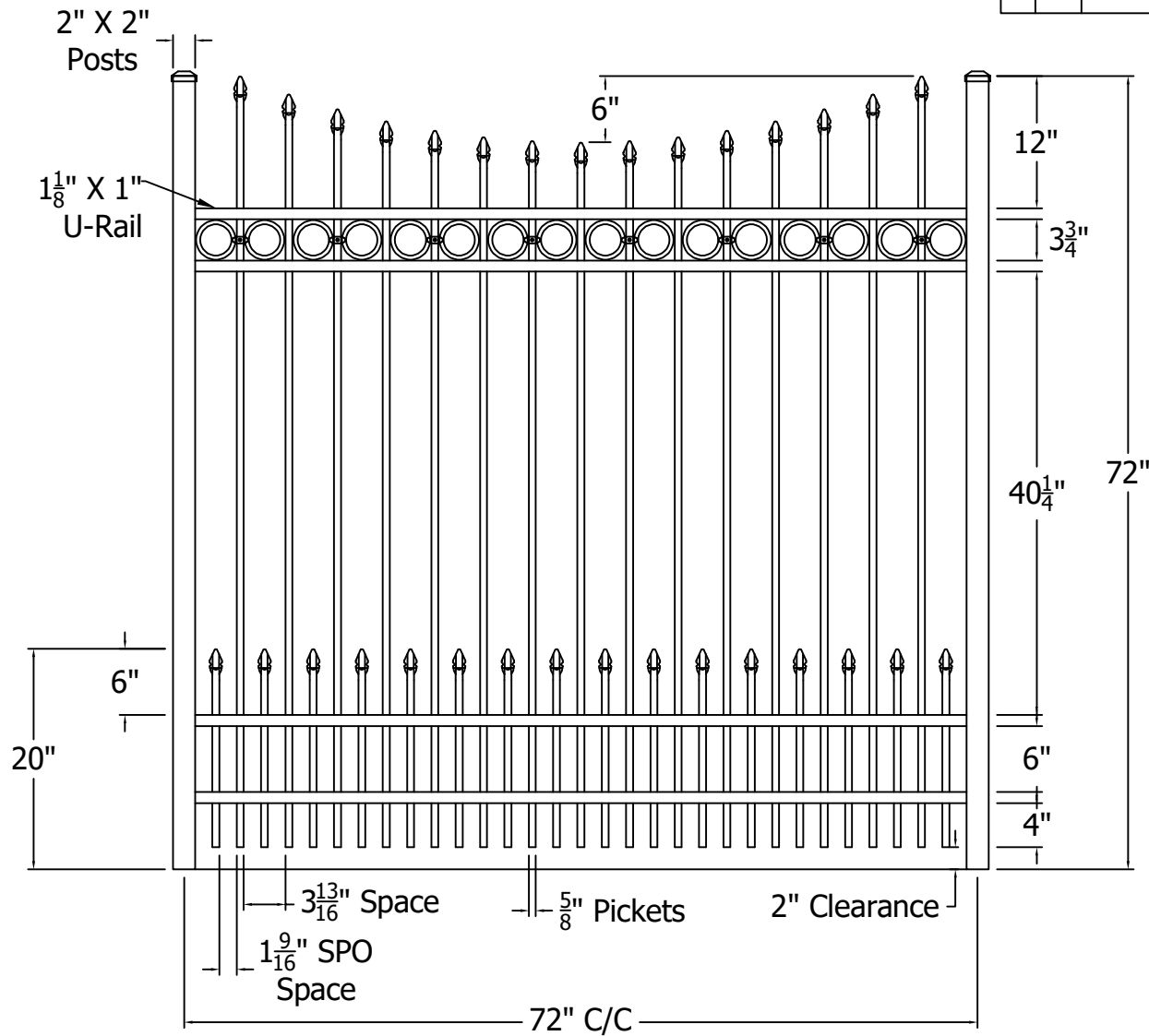

B

A

REV.	LOC.	REVISION	DATE



Finial Options	
 Quad	 Triad
 Fleur-de-lis	

	 3446 US 6 EAST Bremen, IN 46506 diggerspecialties.com	DRAWN BY: EH DATE DRAWN: 01-18-2021 SCALE = 1"=1"	STYLE: <b>0141R Concave Short Picket Option</b> AS SHOWN: 72" T
		DRAFT NO.: 20210118-1E	LOC: Z:\Aluminum\CourtYard\Hundred Series\Hundred SRS Sections\Updated Standard Drawings REV. A

4

3

2

1

D

C

B

A

REV.	LOC.	REVISION	DATE

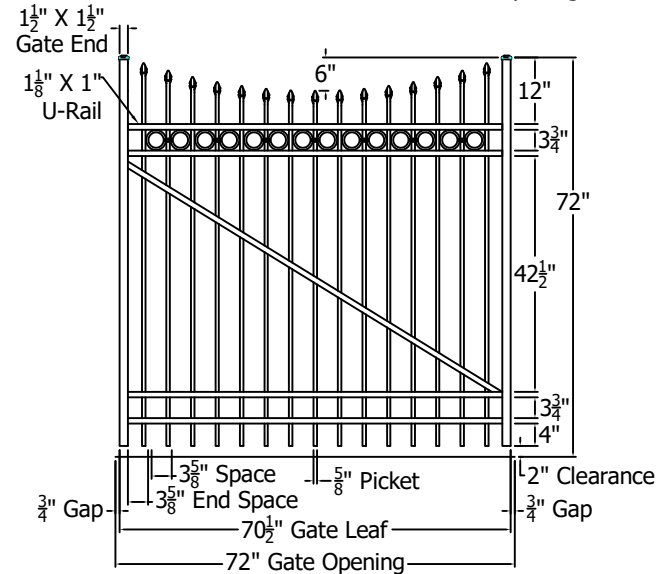
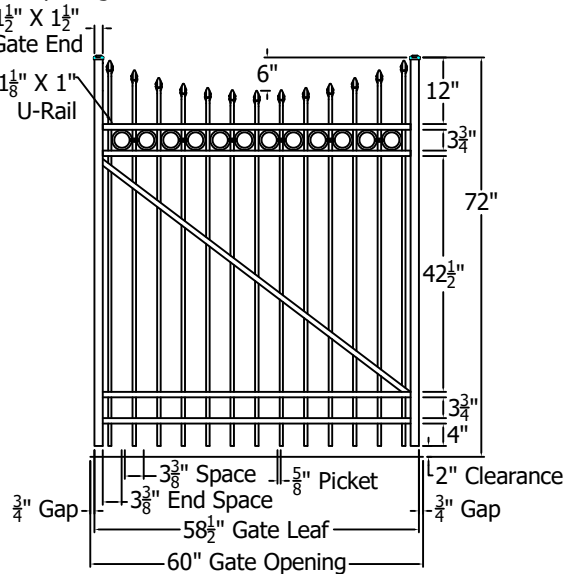
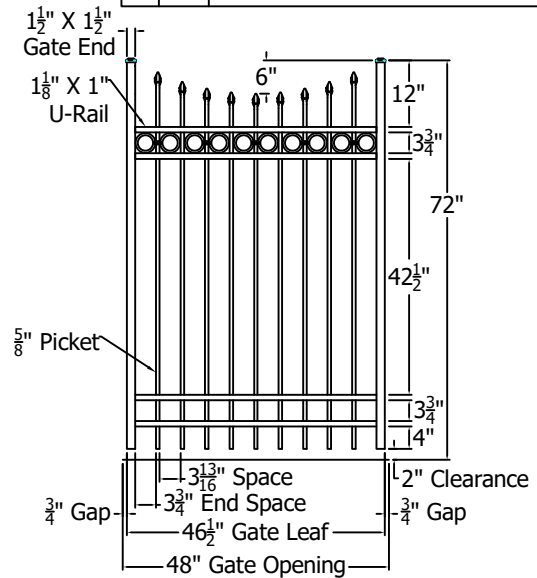
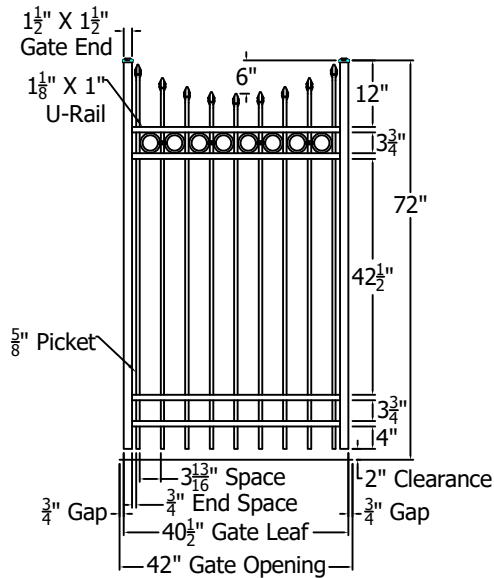
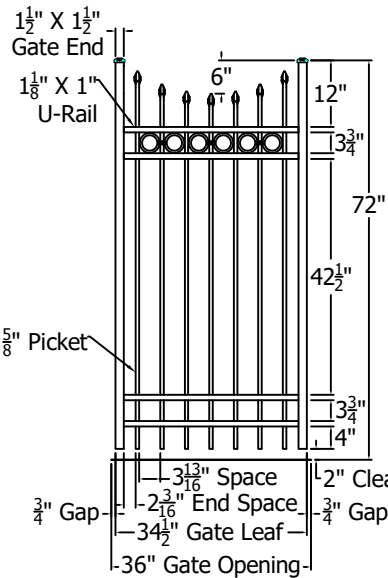

Finial Options	
Quad	Triad
Fleur-de-lis	

	<p>3446 US 6 EAST Bremen, IN 46506 diggerspecialties.com</p>	DRAWN BY: EH	<b>STYLE:</b> <b>0141R Concave Standard Gates</b>
		DATE DRAWN: 01-18-2021	
		SCALE = 1"=1"	LOC: Z:\Aluminum\CourtYard\Hundred Series\Hundred SRS Gates
		DRAFT NO.: 20210118-1E	

4

3

2

1

D

C

B

A